

Natural Sciences and Technology

Grade 5-B

CAPS

Developed and funded as an ongoing project
by the Sasol Inzalo Foundation in partnership
with Siyavula and volunteers.

Distributed by the Department of Basic Education.

COPYRIGHT NOTICE

Your freedom to legally copy this book

You are allowed and encouraged to freely copy this book. You can photocopy, print and distribute it as often as you like. You can download it onto your mobile phone, iPad, PC or flashdrive. You can burn it to CD, email it around or upload it to your website.

The only restriction is that you cannot change this book, its cover or content in any way.

For more information, about the Creative Commons Attribution-NoDerivs 3.0 Unported (CC-BY-ND 3.0) license, see <http://creativecommons.org/licenses/by-nd/3.0/>

The Thunderbolt Kids characters were originally created as part of the Kusasa project (www.kusasa.org), a Shuttleworth Foundation initiative. The Shuttleworth Foundation granted permission for the use of these characters and related artwork.



AUTHORS LIST

This book was written by Siyavula and volunteer educators, academics and students. Siyavula believes in the power of community and collaboration. By training volunteers, helping them network across the country, encouraging them to work together and using the technology available, the vision is to create and use open educational resources to transform the way we teach and learn, especially in South Africa. For more information on how to get involved in the community and volunteer, visit www.siyavula.com

Siyavula Core Team

Megan Beckett, Ewald Zietsman

Siyavula Extended Team

Neels van der Westhuizen, René Toerien, Bridget Nash,
Heather Williams, Dr Mark Horner

Contributors

Ronald Arendse, Prof Ilsa Basson, Rudolph Basson, Mariaan Bester, Darryl Bimray, Brandt Botes, Novosti Buta, Michaela Carr, Kade Cloete, Julian Cowper, Dawn Crawford, Zorina Dharsey, Octave Dilles, Shamin Garib, Sanette Gildenhuis, Nicole Gillanders, CelestÉ Greyling, Martli Greyvenstein, Lee-Ann Harding, Dr Colleen Henning, Anna Herrington, Ruth-Anne Holm, Adam Hyde, Karishma Jagesar, Wayne Jones, Kristi Jooste, Louise King, Paul van Koersveld, Dr Erica Makings, Dhevan Marimandi, Dowelani Mashuvhamele, Glen Morris, Busisiwe Mosiuoa, Andrea Motto, Gladys Munyorovi, Johann Myburgh, Mervin Naik, Alouise Neveling, Owen Newton-Hill, Mthuthuzeli Ngqongqo, Godwell Nhema, Brett Nicolson, Mawethu Nocanda, Seth Phatoli, Swasthi Pillay, Karen du Plessis, Jennifer Poole, Brice Reignier, Irakli Rekhviashvili, Jacques van Rhyn, Kyle Robertson, Ivan Sadler, Thaneshree Singh, H  l  ne Smit, Karen Stewart, James Surgey, Isabel Tarling, Rose Thomas, Dr Francois Toerien, Antonette Tonkie, Wetsie Visser, Vicci Vivier, Karen Wallace, Dawid Weideman, Dr Rufus Wesi, Matthew Wolfe

A special thank you goes to St John's College in Johannesburg for hosting the authoring events which led to the first version of these workbooks.

THIS IS MORE THAN JUST A WORKBOOK!

In many places you will see there are “Visit” boxes in the margins. These boxes contain links to videos online, interesting websites which pertain to the content, or else games or activities for you to complete.

To access these websites or videos, simply type the link provided into your address bar in your internet browser. The links look like this for example, *goo.gl/vWKnF*

You can watch these links in your lessons, at home on a PC, laptop or on mobile phones.

To download these workbooks or learn more about the project, visit the Sasol Inzalo Foundation website at *http://sasolinzalofoundation.org.za*

Welcome to Grade 5 and
to Natural Sciences and
Technology!

Join the
Thunderbolt Kids
on an adventure to explore the
world around us.



Hi there! My name is **Farrah**.

My favourite subjects at school are where I get to be creative and imaginative. But, did you know, this is not only in the art or drama classroom?! We can also be creative in the ways we do Science and Technology. This is especially true when thinking about new ways to answer a question with a Science investigation or drawing a design to solve a problem.

I also really love being outdoors in the natural world around me. This is why I am going to go through **Life and Living and Structures** with you. I think we are very lucky to live in such a beautiful place as South Africa, with so many colours and plants and animals. I am really excited to start learning more about the living world around us.

Sophie is my best friend and she teaches me how to think carefully and solve problems using logic, which is a very good skill to have in Science. Although we can get on each other's nerves, just like best friends do, we have so much fun together and learn a lot from each other.



Hey! My name is **Tom**.

I have two places where I am most happy! The first is in the Science lab because this is where we get to be inventive and tinker away with projects and experiments! My second favourite place is the junk yard! Do you know how many interesting objects you can find there?! I use these objects in my latest inventions.

This is why I am really excited to be going through **Matter and Materials and Processing** with you. This year we are going to learn more about materials, especially metals. And we will get to see how to make new materials. I find this really interesting, especially to see how these methods have evolved over time.

I also really enjoy maths and thinking about how we can solve problems logically. Jojo is one of my best mates, although he can be very messy at times! But, Jojo helps me get involved with my whole body when trying to solve problems in our daily lives, and not just use my mind.





What's up! My name is **Jojo**.

I just want to dive straight into this year, and especially Natural Sciences and Technology. Sometimes though, I find it hard to sit still in class as I just want to get up and do things! My teacher often says I have too much energy and I battle to sit still in class. Maybe that's why I am going through **Energy and Change and Systems and Control** with you this year.

I am really looking forward to understanding more about what "energy" really is! And, this year we start to learn about electricity. The best part about Natural Sciences and Technology for me is that we get to learn actively. We have goals and questions which we want to answer and I am always the first to leap into action!

Tom and I make a very good team because he is very good at thinking and planning and then following a method. But, I think I can also help as sometimes Tom wants to think too much, whereas in Science and Technology you also have to get involved in the subject and start experimenting.

Hello! My name is **Sophie**.

One of my favourite places to be is in the school library. I love reading a new book - there is just so much to learn and discover about our world!

I am always asking questions and often these questions do not yet have answers to them. To me, this is fascinating as we then get to make a theory about what we think the answer might be. This is why I really enjoy learning about outer Space as there is so much that we do not know. Throughout history people have been asking questions about Space and our place in the universe. This is why I am going to go through **Earth and Beyond and Systems and Control** with you. This year we will look more at our planet Earth and I am really interested to find out more about fossils.

I also like expressing my opinion and debating about a topic. You have to give me a very good argument to convince me of your opinion! I love exploring with Farrah as she helps me to be more creative and imaginative in the way that I think. I can also be quite sceptical and do not believe everything I read. But, this is very important in Science as we must not always accept everything as fact.



Join the
Thunderbolt Kids
by adding your details here!

My name is:

My favourite subject is:

On the weekends, I love to:

My friends' names are:

One day, I want to:

STICK OR DRAW
A PICTURE
OF YOURSELF
HERE!



Table of Contents

Energy and Change	4
1 Stored energy in fuels	4
1.1 What are fuels?	4
1.2 Burning fuels	15
1.3 Safety with fire	20
2 Energy and electricity	30
2.1 Cells and batteries	30
2.2 Mains electricity	35
2.3 Safety and electricity	38
3 Energy and movement	44
3.1 Elastics and springs	44
4 Systems for moving things	54
4.1 Wheels and axles	54
Earth and beyond	74
1 Planet Earth	74
1.1 The Earth moves	74
2 Surface of the Earth	88
2.1 Rocks	88
2.2 Soil comes from rocks	99
2.3 Soil types	114
3 Sedimentary rocks	136
3.1 Formation of sedimentary rock	136
3.2 Uses of sedimentary rock	144
4 Fossils	152
4.1 Fossils in rock	152
4.2 Body and trace fossils	163
4.3 Importance of South African fossils	165
5 Notes	178

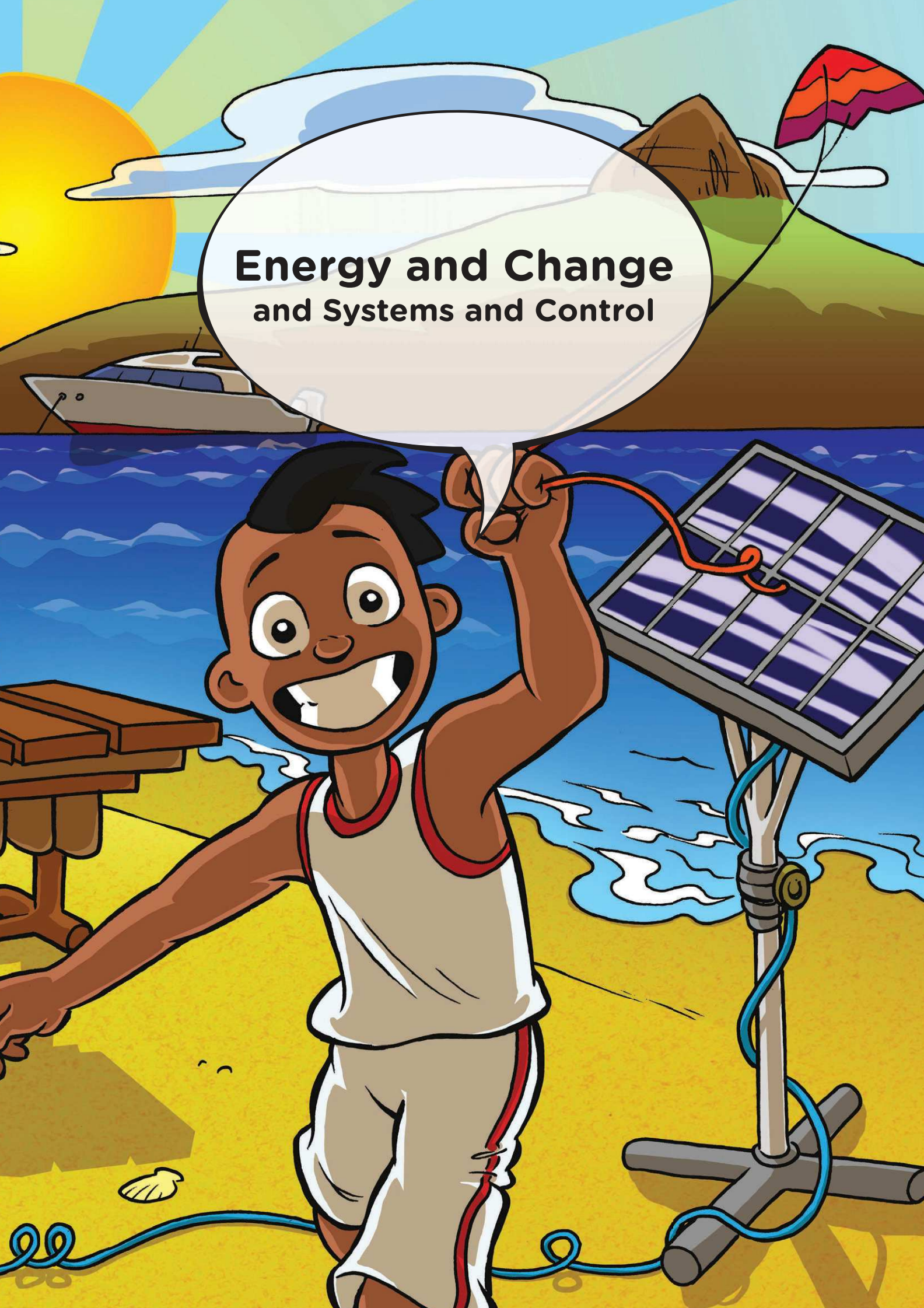

A vibrant, cartoon-style illustration of a young boy with dark skin and hair, wearing a white tank top and shorts, running happily on a yellow beach. He is holding a large, white, cloud-like speech bubble above his head. To his right, a solar panel is mounted on a metal stand, with blue and orange cables connected to it. In the background, there is a blue ocean with a white boat, a large yellow sun, a green hill with a brown mountain peak, and a colorful kite flying in the sky. The overall scene is bright and cheerful, suggesting a theme of renewable energy and outdoor activity.

**Energy and Change
and Systems and Control**



KEY QUESTIONS

- What are fuels?
- What is needed to burn fuels?
- How can we safely burn fuels?
- How can we prevent fires and what must we do if there is a fire?

NEW WORDS

- fuel



1.1 What are fuels?

In Grade 4, we learnt that there are many different types of energy. This year we are going to learn about stored energy and how we can use the stored energy to do something useful.

QUESTIONS

What do you understand by the term fuel? Discuss this word with your partner and write down your own definition below.



There are a few different definitions for fuel. There are three main categories that you can use to investigate fuels.

Some fuels can be burnt to create heat and light

Wood is often collected and burnt to give us heat and light. On a cold evening it is wonderful to sit around a fire to tell stories and warm yourself with friends.



This man has made a fire to keep warm and provide light. ¹



Cooking meat on a fire made from wood in Khayelitsha. ²

Wood comes from plants, especially trees. When plants are growing, they use the light energy from the sun as well as carbon dioxide and water to grow. Plants take the energy and store it in their leaves, roots and all parts of the plant. Wood also contains this energy stored by plants. Burning wood allows us to change this stored energy into light and heat which is useful to us.

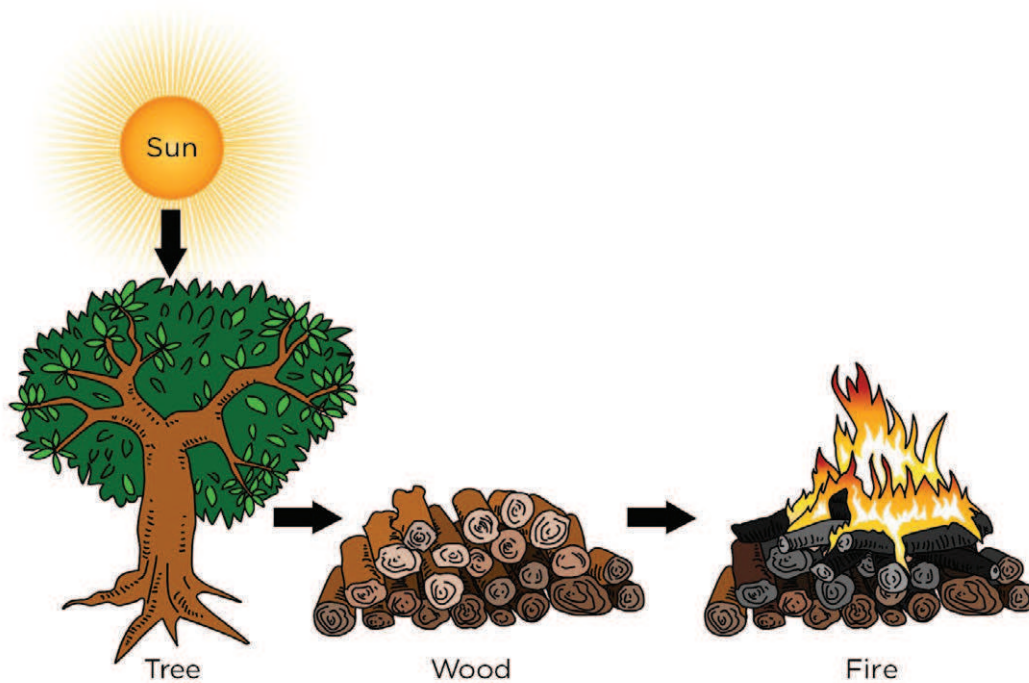

Energy from the sun is stored in the tree's wood which is released as light and heat when we burn the wood.

VISIT
Formation of fossil fuels (video).
goo.gl/y04IH



Coal is a type of fossil fuel that is also burnt to provide us with heat that we can use. The heat from coal can be used to cook our food and warm our houses.



Hot coals burning.

Fossil fuels like coal were made from prehistoric plants. The plants got their energy from the Sun and stored it in their bodies. Millions of years ago, a lot of the Earth was covered by water. The plants that died sank to the bottom of the water. Over millions of years, the layers of plants were covered by layers of sand and pushed down by the weight of the sand. The plant material was buried deeper and deeper under the ground where it is much hotter than on the surface of the Earth. Over millions of years, the plant remains are changed into fossil fuels.

Fossil fuels get their name "fossil" because they are made from plants and animals that were alive a long, long time ago.

Other types of fossil fuels are natural gas and oil. Scientists have realized that tiny sea organisms, also died, sank to the the bottom of the ocean and were buried under the sand. Over millions of years, many layers of dead sea animals got buried like this. over millions of years, the dead sea animals changed into oil and natural gas

Wax in a candle is burnt to provide light. There is stored energy in the wax and burning it, allows us to change the stored energy into light.



Candle wax is an everyday fuel that we use to give us light.

Paraffin is also a fuel that contains stored energy. Paraffin is burnt in paraffin lamps and paraffin stoves to provide us with useful energy in the form of light and heat.

VISIT
How fossil fuels are made.
goo.gl/rxiVG





A paraffin lamp. ³

Food is fuel for the body

In order to live, people and animals need energy. We get our energy from the food that we eat. Do you remember learning about food chains in the beginning of the year in Life and Living?

QUESTIONS

Choose one of the foods that you will eat for lunch today and draw a food chain including this food and ending with you.



Food contains stored energy that our bodies can change into useful energy that we need when we run, jump, breathe, learn and everything else that we do.

So we can say that food is the fuel for our bodies! I must need a lot of fuel for my body as I love being active!



The energy value of food is often shown on the packaging of foods that we buy. The energy of food is measured either in calories (Cal) or in joules (J). A snack such as a packet of chips gives you thousands of joules of energy. So we rather talk about kilojoules of energy when talking about the energy in food.

Have a look at the photo of the side of a mealie meal packet below. The side of the packet contains a lot of information about what the mealie meal contains. The very top line tells us that 100 g of mealie meal will supply your body with 1368 kJ of energy.

TYPICAL NUTRITIONAL INFORMATION			% NRV (≥4 yrs)
Daily serving size: 100 g			
		Per 100 g	
Energy	(kJ)	1368	100
Protein	(g)	5.6	
Glycaemic carbohydrates	(g)	72	
of which total sugars	(g)	1.8	
Total fat	(g)	0.7	
of which saturated fat	(g)	0.1	
of which trans fat	(g)	< 0.01	
of which monounsaturated fat	(g)	0.2	
of which polyunsaturated fat	(g)	0.4	
Cholesterol	(mg)	< 1	
Dietary fibre #	(g)	2.5	
of which insoluble fibre	(g)	2.3	
of which soluble fibre	(g)	0.2	
Total sodium	(mg)	< 6	
Vitamin A	(µgRE)	188	
Thiamine (B1)	(mg)	0.3	
Riboflavin (B2)	(mg)	0.2	
Niacin (B3)	(mg)	3.0	
Pyridoxine (B6)	(mg)	0.4	
Folic acid (B9)	(µg)	189	
Iron	(mg)	3.7	
Zinc	(mg)	1.9	

* Nutrient reference values (NRVs) for individuals 4 years and older
 Analysed by a SANAS and/or ILAC accredited laboratory. Nutri
 # ACIAC 985.29

The nutritional information on a mealie meal packet.

The energy value of a food tells us how much energy that food is worth to our bodies as fuel. An average adult man needs about 2500 kcal or 10 000 kJ per day. Children and adults that are not very active need less energy. People that are very active need more energy. These numbers are just to give us an idea of the amount of energy your body needs as fuel everyday.

It is important to eat a balanced diet. In the next activity we are going to look at how much energy different food gives us. Next year in Grade 6 we will learn a lot more about nutrition and what you should eat to be healthy!

ACTIVITY: Energy from food

MATERIALS:

- various packaging for foods collected from home

INSTRUCTIONS:

1. Work in pairs.
2. There is a collection of packages from different types of foods in your classroom.
3. Look carefully at the energy information given on the packets and use this information to complete the table.
4. It is important to record the number and the unit in your table.



Food item	Energy per 100g

QUESTIONS:

1. Which food item contains the most amount of energy per 100g?

2. Which food item contains the least amount of energy per 100g?

Some fuels are energy sources for engines and power stations

Fuels can also be used to give us other forms of useful energy.

Petrol or **diesel** is used in cars and trucks to make them go. The stored energy in the fuel is changed into movement energy of the car or truck.



Putting petrol into a car at a petrol station.

Petrol and diesel are made from fossil fuels. Can you see that even energy for cars and generating electricity comes from the Sun?

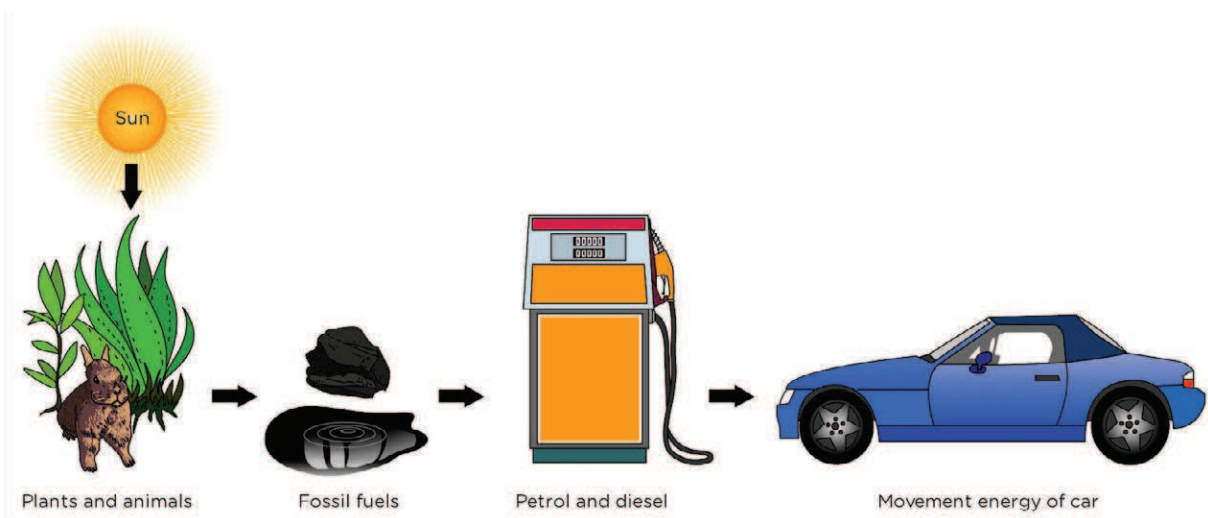

Energy from the Sun is stored in the plants and animals which eat the plants. Their remains turned into fossil fuels over millions of years which are then mined and used to make petrol and diesel to fuel cars.

Coal is not only burnt in our homes for cooking and keeping us warm. It is also burnt in large quantities to make electricity. A power station is a large factory where the coal is burnt in large amounts to produce electricity.



A power station.

We can also do an investigation to find out how much energy is stored in fuels.



INVESTIGATION: How much energy can we get from different fuels?

AIM: To determine which fuel contains the most amount of energy

MATERIALS AND APPARATUS:

- a cork
- a needle
- peanuts (other fuels such as a piece of wood, candle wax or piece of biscuit)
- a large metal can (eg coffee tin)
- a small metal can (eg soup can) with paper label removed
- a can opener
- a hammer
- a large nail
- a metal spike longer than the diameter of large can
- 150 ml of water
- a thermometer
- a lighter

Method:

1. Carefully push the eye of the needle into the smaller end of the cork. Then gently push the pointed end of the needle into a peanut. If the peanut breaks use another peanut.

VISIT

Burning a peanut
(video)
goo.gl/JoXw6

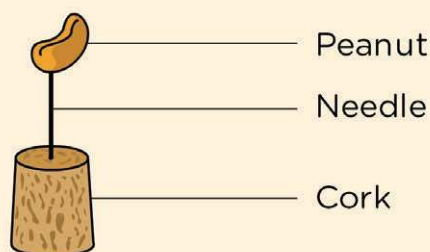

Set up your peanut and cork like this.

2. Remove both ends of the large can. Watch out for sharp edges.
3. Use the hammer and nail to make holes all around the bottom of the large can. These are air holes.
4. Use the small can and punch two holes near the top of the can exactly opposite each other.
5. Slide the metal spike through the two holes in the small can.
6. Pour 150 ml of water into the small can.
7. Use the thermometer to measure the temperature of the water and record it in the results table.
8. Put the cork and peanut on a surface that cannot burn. Use the lighter to light the peanut. The peanut can be difficult to light so keep trying. It will eventually start burning.
9. As soon as the peanut is burning, carefully place the large can over the peanut. Balance the small can inside the big can as shown in the diagram. The small can must be a short distance above the peanut.

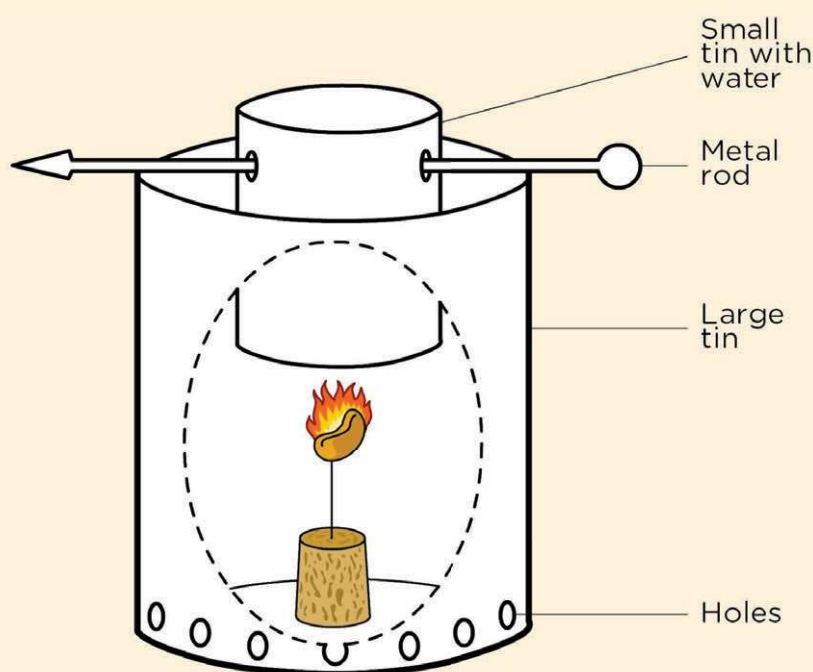

Set up your apparatus like this.

10. Let the peanut heat the small can with the water until the peanut stops burning. Stir the water and measure the temperature of the water and record it in the results table.

11. Repeat the experiment with two different fuels. Your teacher will decide which fuels to test. Fill in the results table for the other fuels tested. Remember to use quantities of the other fuels which are similar in size to the peanut, and to always start with a cold can of water.

RESULTS:

	Fuel 1: Peanut	Fuel 2: _____	Fuel 3: _____
Temperature of water before heating (°C)			
Temperature of water after heating (°C)			
Change in temperature (°C)			

CONCLUSION:

Write a conclusion for your investigation.

QUESTIONS:

1. Which fuel contained the most amount of energy and how did you determine this?

2. Where did the energy in the peanut originally come from?

3. Discuss what happened to the energy stored in the nut, or other fuels you used.

4. What was the input energy needed to make the peanut (and other fuels) burn?

5. What was the output energy obtained from the fuel?

6. Discuss how you could compare the amount of energy stored in peanuts to the amount of energy stored in a cashew nut.

In order to light the fuel, you had to put in a small amount of energy. The fuel however gave out a lot more energy than what was put in. The difference between the energy you put in and the energy the fuel gave out is how much energy was stored in the fuel.

The **OUTPUT ENERGY** obtained from a fuel is **GREATER THAN** the **INPUT ENERGY** needed to make the fuel burn.

1.2 Burning fuels

We have learnt that burning fuels provides us with energy that we can use. What does a fuel need to be able to burn?

Burning fuel requires some energy to start burning. Fuel needs oxygen to burn. Fuel usually gets oxygen from the air around it.

NEW WORDS

- oxygen
- combustion



There are other gases present in air as well, but they do not burn.

The following pie chart illustrates how much of each type of gas is found in the air around us.

VISIT
The science of fireworks (video).
goo.gl/d4HJj

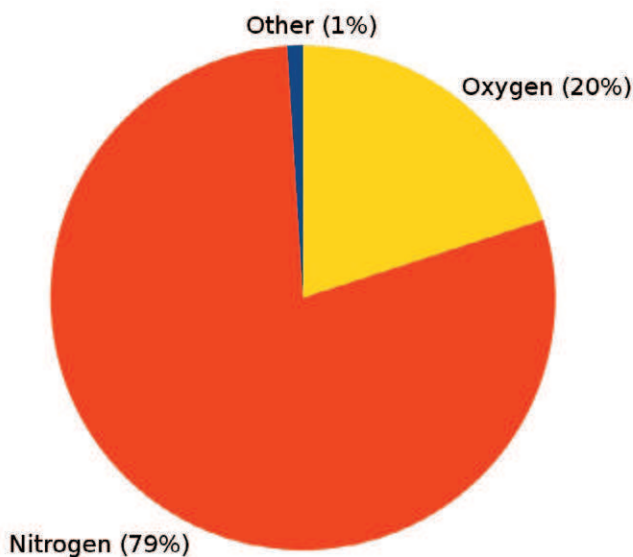

Pie chart showing the percentage of gases in the air around us.



QUESTIONS

1. How much of the air around us consists of oxygen?

When something burns we say it is combusting. So, another word for burning is combustion.

So, what happens to a flame when we take one of these things away, such as oxygen? When we take something away, we say we deprive it. Let's find out what happens when a flame is deprived of oxygen!

INVESTIGATION: What happens when a flame is deprived of oxygen?

AIM: To find out how long a candle will burn when given different amounts of oxygen.

MATERIALS AND APPARATUS:

- 1 candle
- 4 glass bottles (small, medium, large and extra large)
- matches
- 1 flat bottomed bowl

METHOD:

1. Light the candle.
2. Drip some wax in the middle of the bowl and 'mount' a candle in the wax.
3. Pour a small amount of water in the bowl around the candle for the glass jars to stand in.
4. When the candle is securely standing upright, light the candle with the matches.
5. Place the small bottle over the candle and time how long it takes until the candle goes out. Record the time taken in the results table.

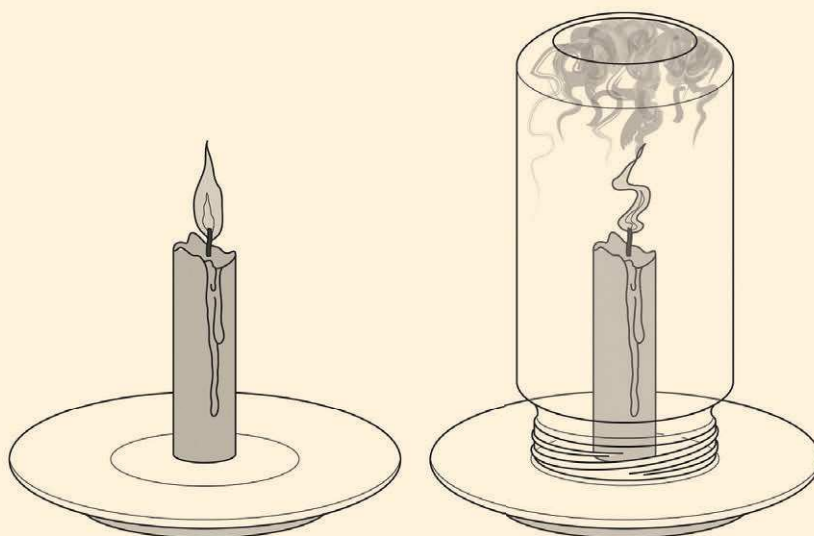

Cover the candle as shown with each of the different sized bottles.

- Repeat the experiment with each of the different sized glass containers and record the time taken for the candle to go out.

RESULTS AND OBSERVATIONS:

Size of glass jar	Time taken for candle to go out (s)
Small	
Medium	
Large	
Extra Large	

- In which glass jar did the candle last the longest?

- In which glass jar did the candle burn out the fastest?

CONCLUSION:

Write a conclusion for the investigation.

QUESTIONS:

1. When lighting a candle, identify the heat source that provides the starting energy and the fuel supply.

2. Why did the candle go out once you put the glass jar over the candle?

3. Why do you think there is a difference in the time taken for the candle to go out?

4. A candle that is allowed to burn freely in air will eventually burn down and go out. Why does the candle stop burning in this situation?

What we have learned is that if you take away the fuel or the oxygen, burning will stop.

For combustion to be possible, a heat source, fuel and oxygen are needed. Without one of the three, combustion will not happen. You can remember this using the Fire Triangle. All three sides of the triangle are required for combustion.

VISIT

Burning substances in air and pure oxygen (video).
goo.gl/sEV5g

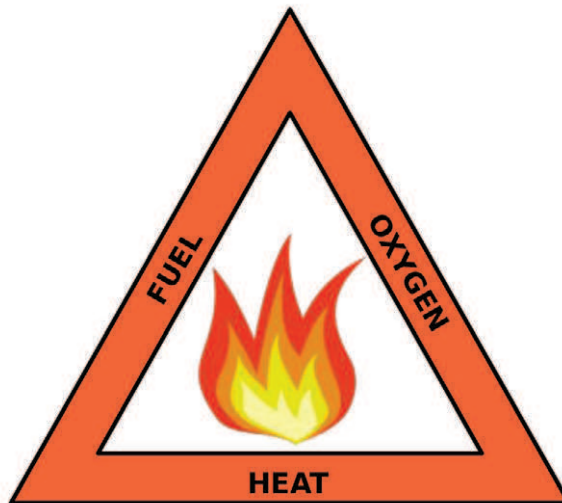

The combustion triangle.

NEW WORDS

- threat
- extinguish

1.3 Safety with fire

We have spoken a lot about fire and burning in this chapter so far. Fire is a major source of heat energy for many people whether it is for keeping warm, cooking food or for some other purpose. Although fire is very useful it is also very dangerous! Great care is needed when using fire. Fire is a threat in our communities.



This is a wildfire which has gotten out of control.



This is a warning in a nature reserve during the dry summer months when fires can easily start up.

DID YOU KNOW?

Some plants even need fire to survive! An example is Fynbos. This is a group of plant species found only in South Africa. The seeds of Fynbos plants need smoke and heat to germinate.

There are a few safety rules that everybody should know:

1. Never play with matches and lighters. Make sure that matches and lighters are kept out of reach of young children who do not know how to use them properly.



2. In case of fire - stay away. If there is a fire in your home, do not hide, rather go outside as soon as possible.
3. Know the number of the local fire department and phone in case of emergency.
4. Have an escape plan for your home and practice it with your family. Have a meeting place outside so that you will know everyone is safe in the event of a fire.

ACTIVITY: Dangerous situations involving fire.

INSTRUCTIONS:

1. Below are four different scenes.
2. Each one is potentially dangerous involving fire.
3. Write a description next to each picture about why it is dangerous.



Situation	Why is it dangerous?
	
	
	

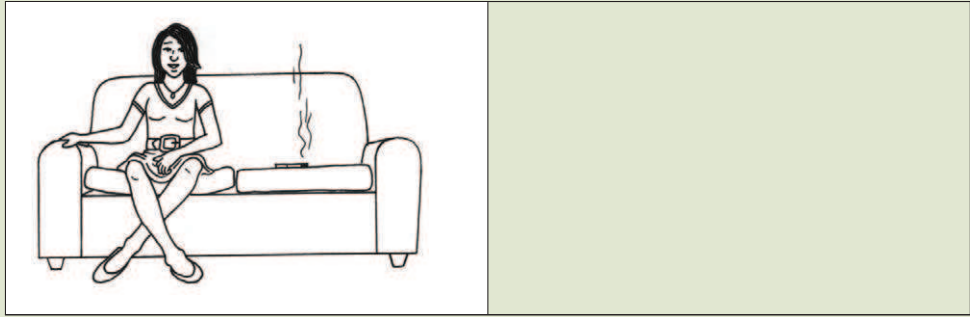

Fire alarms are extremely important to warn people in buildings that a fire has started.



*You should have some fire extinguishers in your school.
See if you can locate them.*



ACTIVITY: Talking about fire in our communities

1. Work in groups of four.
2. Talk about your experience of fire in your neighbourhood. List some good and some bad experiences in the table below.

Good experiences of fire	Bad experiences of fire

3. What causes of fire can you identify in your community?

4. How could you prevent each of the causes of fire you have been discussing?

Sometimes fires happen and we need to know what to do in the event of a fire.



ACTIVITY: Acting out what to do in case of a fire!

INSTRUCTIONS:

1. In groups of 5, plan and act out a play for your class to teach them what to do in case of a fire.
2. Make sure that your play gives important information about:
 - a. how to escape from a burning building
 - b. not to open a door in a building that is burning
 - c. what to do if your clothes are on fire
 - d. what to do if your friend is stuck in a burning building

Have you ever seen any fire posters in your school telling you what to do in case of a fire? Did this poster catch your attention and make you aware of the dangers that fire can hold in your school? Maybe your school does not have any fire posters. Let's create our own fire posters to put up in the school.



ACTIVITY: Creating a fire poster

MATERIALS:

- Pieces of paper and cardboard.
- Coloured pens and pencils.
- Old magazines
- Scissors
- Glue

INSTRUCTIONS:

1. Design a poster telling everyone in your school what to do if there is a fire.

2. Include some pictures to show the steps to follow. You can draw these pictures or cut some out of old magazines or newspapers.

3. Some points to think about when making your poster:

- Does your school have an alarm bell?
- If so, what is the signal?
- Is there a safe place that a large amount of people can gather?
- How will you make sure no one is left inside the buildings?
- Is it safer to use the lift or the stairs when there is a fire?
- What extra measures can you take to stop the fire? (Clue: Remember fire needs oxygen to burn so what can you do to your classrooms to help stop the fire and reduce the supply of oxygen?)

DID YOU KNOW?

Smoke inhalation (breathing in the harmful smoke) from a fire kills more people in household or domestic fires than the actual fire does.



KEY CONCEPTS

- Energy is stored in fuels
- Fuels are sources of useful energy
- Fuels are burnt to be able to use their energy as heat and light
- Fire can be dangerous





REVISION:

1. List three types of fuel that you use in your community.

2. What is needed for combustion to take place?

3. Your dad is cooking with hot oil on the stove. The oil catches fire. Suggest a way to put out the fire and explain why it will work.

4. An enthusiastic Science learner decides to perform an experiment to find out how long different quantities of firelighters will last. Each firelighter was cut into equal size blocks. The experiment was performed under adult supervision, and the following results were obtained:

Number of firelighters	Time of burn (min)
2	6,0
4	11,5
6	18,6
8	23,8
12	37,0
16	48,0

- a. Plot a graph of number of firelighters on the horizontal (x) axis and the time of burn on the vertical (y) axis.
- b. Draw a line of best fit on your graph.



1. Describe the relationship between the time of burn and the number of firelighters.

2. Use your graph to find out how long ten firelighters would burn.

3. Your mom leaves the iron on and it is next to a window with a curtain blowing in the wind. Explain to her why this is dangerous and what she should rather do.

I really enjoyed learning about fuels! Let's now find out more about energy and electricity.





KEY QUESTIONS

- What do cells and batteries do?
- What is an electrical circuit?
- Where does energy come from in a power station?
- How does electricity get from a power station to where it is needed?
- How can we use electricity safely?

NEW WORDS

- cell
- battery
- circuit
- pacemaker



2.1 Cells and batteries

Batteries come in all shapes and sizes. Batteries are needed for many different purposes. Most torches, radios, calculators, cell phones, some toys and even cars, pacemakers and hearing aids need a battery to work.



Typical batteries.

Batteries are useful as they store chemical energy. When the battery is connected in an electrical appliance and it is turned on, the stored energy in the battery is changed into electrical energy which is used to make the appliance work.

ACTIVITY: Investigating the source of electricity in a torch.

MATERIALS :

- a working torch
- an old, broken torch

INSTRUCTIONS:

1. Turn your torch on and off. Can you see the bulb light up?
2. Turn your torch off and open it up and take the cells out (remember that 'cell' is the scientific for what most people call a battery in everyday life.).
3. Now turn it back on.

QUESTIONS:

1. Does the bulb light up when there are no batteries in the torch?

2. What does this tell you about the need for batteries to use your torch in the dark?

3. Do you remember learning about transfer of energy in Gr 4? When the torch lights up, what is the chemical energy in the battery transferred into?



4. Bring an old torch to school that can be taken apart. Look carefully at all the parts that make up a torch and make a list of what you find. Each part of the torch is needed for the torch to work properly.

When the electrical energy is transferred to where it is needed, then we say that we have a circuit. A circuit is a system and consists of different parts.



Chemical energy in the battery in the torch is changed into electrical energy which is changed into light.



ACTIVITY: Making a simple circuit

MATERIALS:

- 2 torch batteries
- 1 light bulb
- connecting wires

INSTRUCTIONS:

Part 1

1. Set up the circuit as shown in the diagram.
2. Make sure all the wires are connected to form a closed loop.

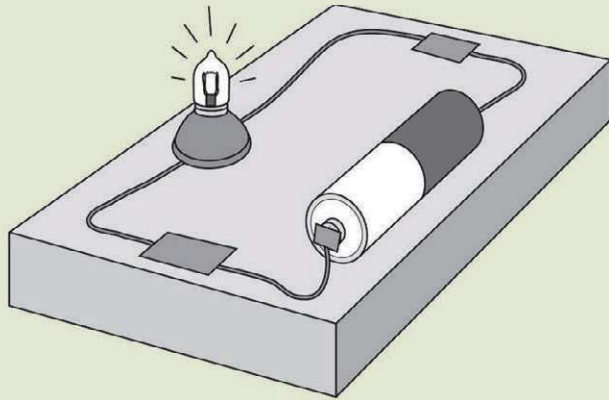

A simple circuit.

QUESTIONS:

1. What do you observe?

2. What happens when you disconnect one end of one of the wires?

3. The one end of the battery is labelled positive and the other end is negative. Draw a diagram of the battery and label the ends as positive or negative.

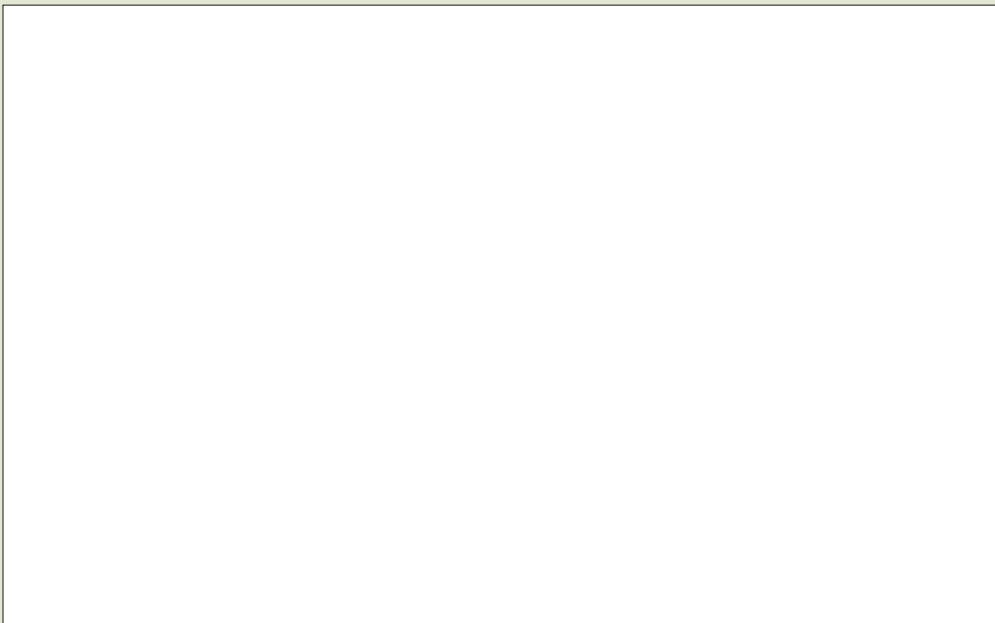

Part 2

1. Set up a new circuit with 2 batteries and 1 globe.
2. Explain how you connected the batteries so the globe still lights up.

3. Describe if the globe glowed the same or brighter or dimmer than in experiment 1?

4. Explain your answer to question 2.

5. Describe an electrical circuit.

Two or more cells connected end to end are called a battery. One cell stores a small amount of energy. If we need to store a lot of energy we use a battery.

A car needs energy to start its engine. One cell does not have enough stored energy. A car battery is actually six cells that are connected end to end inside the battery case. There is six times more energy stored in the battery than in a single cell. This gives the car enough energy to start the engine.



A car battery contains 6 cells.



Mmm...so a torch needs two batteries to light up. I wonder how many batteries are needed to light up our house?!

Good question Jojo! Let's find out in the next section.

2.2 Mains electricity

A battery has stored energy which can be changed into electrical energy. But our homes, schools, shops and factories cannot run on batteries. Electricity does a lot of work for us and is used many times every day. The main source of electrical energy is from power stations. We call this "mains electricity".



A power station.

Power stations need a source of energy

Power stations use different ways to generate electricity. A power station needs a source of energy. In South Africa, most of our power stations burn coal to use the energy stored in coal to generate electricity.

NEW WORDS

- transmission lines
- pylons



VISIT

Electricity generation (video).
goo.gl/32irY





QUESTIONS

Coal is not the only source of energy for power stations, there are also other types of power stations. Find out what these are and write down what source of energy they each use.

Electricity is transferred in a huge circuit to our homes

From a power station, electricity is transferred through transmission lines held up by pylons. The transmission lines are part of the circuit that connects the power stations to where we need to use the electricity.

Do you remember learning about the structures of pylons in Grade 4 in Matter and Materials? Remember they are made from triangular shapes and struts to make them strong and stable!

VISIT

Making electricity from coal (video).

goo.gl/Hzu5V and goo.gl/scUhl



Huge pylons carrying the transmission lines across the country.

The transmission lines carry large amounts of electricity to substations in cities and towns.

From a substation, electricity is carried in smaller amounts to an electricity box for our home. From the electricity box, electricity travels through wires to the plug points and light fittings in our homes.

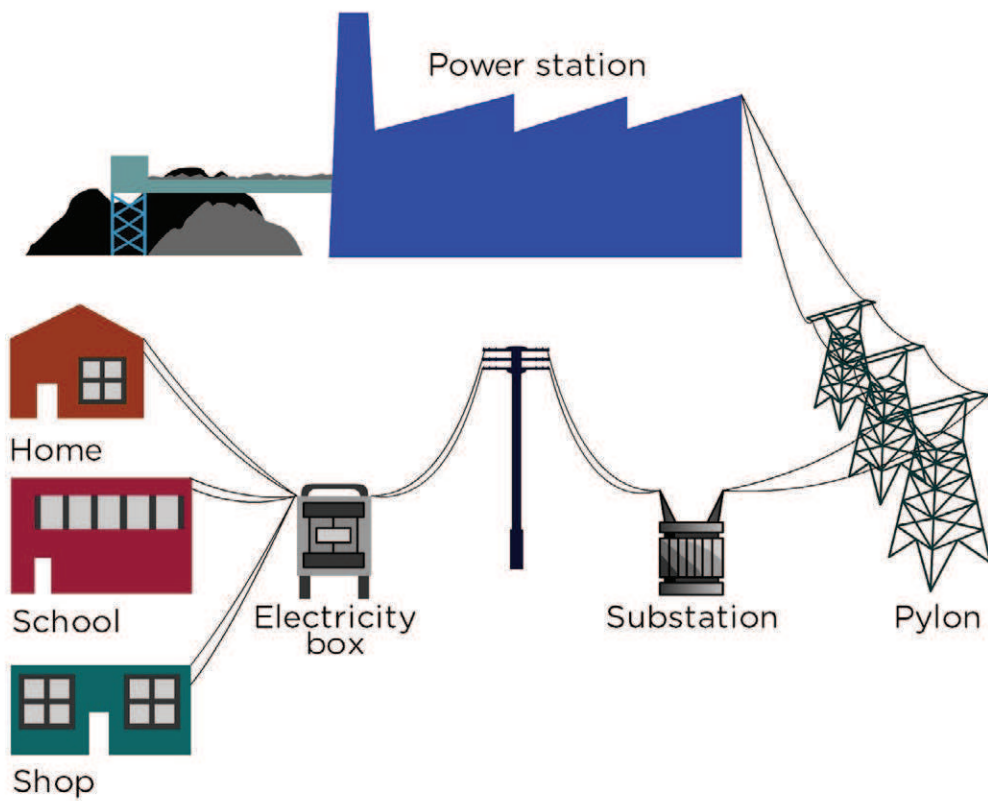

The transfer of energy from power stations to our homes, schools and shops.

QUESTIONS

The above diagram shows how electricity is transferred from the power station to your home. Continue the diagram (use the space below) to draw the path of electricity once it is in your home and goes through the wires, wall socket and plugs to get to an appliance, such as the TV.

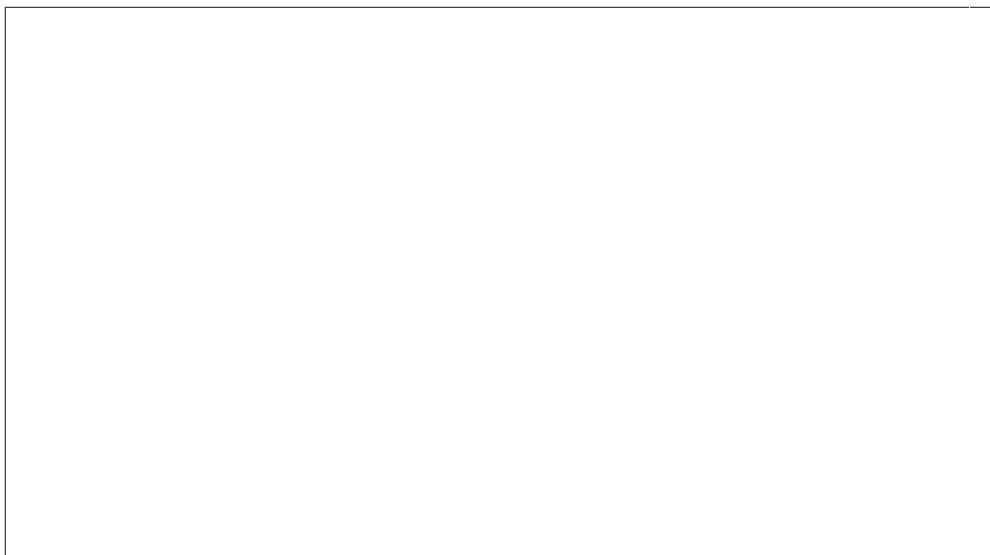

2.3 Safety and electricity

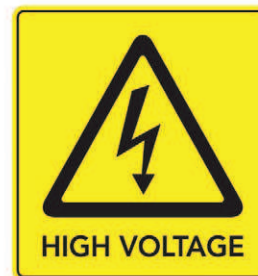

We use electricity every day. Electricity can be dangerous, so it is important that we use it safely. Electricity can give you an electric shock. An electric shock can hurt you badly or even kill you.

High voltage is very dangerous. Look out for warning signs like these!

Electricity can cause fires and injuries, even death. Here are some rules for using electricity safely:

1. Do not put anything into an outlet except a plug.
2. Do not pull on the cord to unplug an appliance, hold the plug and pull.
3. Dry your hands before you plug in or unplug a cord.
4. If a plug is broken or a cord is cut or worn, do not use it.
5. Do not plug too many cords into one outlet.
6. Keep appliances away from water. Do not use a hair dryer if there is water nearby.
7. If there is an electrical storm (with lightning), turn off and disconnect electrical appliances, like the TV and computer.
8. Do not touch any power lines.
9. Some power lines are buried underground. If you are digging and find a wire, do not touch it.
10. Do not fly a kite or climb a tree near a power line.

VISIT
Interactive site about
electricity.
goo.gl/mrFiy







ACTIVITY: 10 Safety tips for electricity

INSTRUCTIONS:

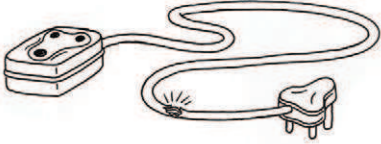
1. Look at the pictures.
2. Each picture shows the **INCORRECT** use of electricity or electrical appliance.
3. Use the picture to write a "Safety tip" for the situation in the picture.
4. The first example has been done for you.

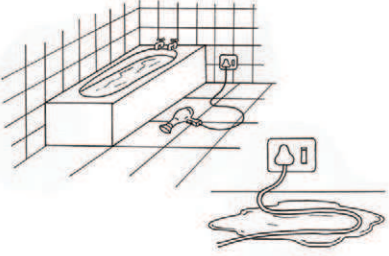

Picture	Safety tip
	<p>Never use an appliance that has a broken cord or has some of the metal wire showing through the cord casing.</p>
	
	
	
	

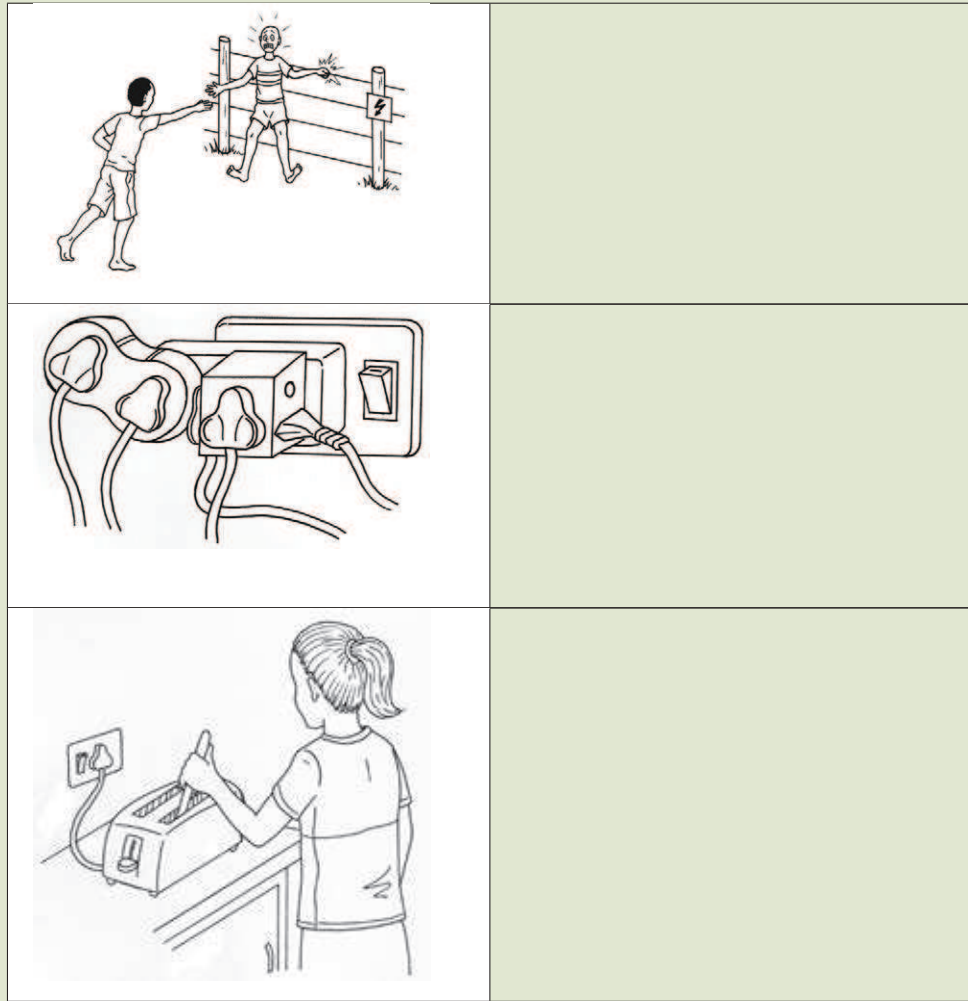

KEY CONCEPTS

- Energy can be stored in cells and batteries.
- The cells or batteries are a source of electrical energy for an electric circuit.
- An electrical circuit is a system that transfers electrical energy to where it is needed.
- A power station needs a source of energy.
- Electricity from the power station is transferred in a circuit to our homes.
- Electricity can be dangerous and needs to be used safely.

REVISION:

1. Why do torches need cells (battery) to operate?

2. What is an electric circuit?

3. How is a battery different to a cell?

4. Draw a diagram of a simple circuit containing one cell and one bulb so that the globe will glow.



5. How is it possible that electricity that is generated at a power station, reaches a TV in a home that is far away from the power station? Describe how the energy is transferred from a power station to your home.

6. When should you NOT handle electricity or electrical appliances?

7. Choose the correct answer: If someone is being shocked by an electricity source, I should:
- a. Try to pull them away from the source of the electricity.
 - b. Throw water on them to cool down the shock.
 - c. Turn off the power source as quickly as possible then attend to them.
 - d. Attend to them then turn off the power source as quickly as possible once they are safe.

8. Give a reason for the following statement: Do not play under or near power lines or electric fences.



KEY QUESTIONS

- How can stored energy be changed into movement energy?
- How can we make things move using stored energy?

Do you remember in Grade 4 when we looked at energy and movement in a system? We were mostly looking at musical instruments and how they use movement energy (the input) such as plucking or blowing, to make them work.

In this chapter we are going to look at some other ways of using stored energy to produce movement energy.

NEW WORDS

- catapult
- stretch
- compress
- store
- potential



3.1 Elastics and springs

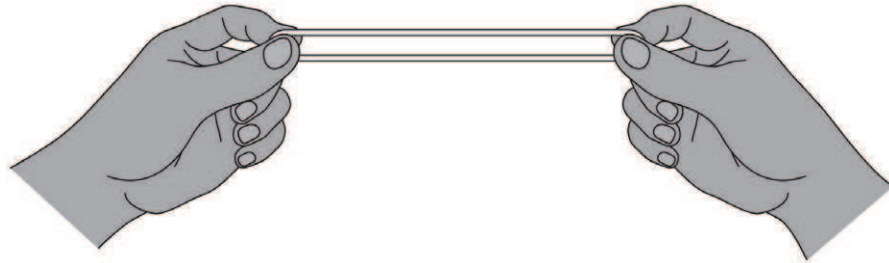

Stretching an elastic band.

QUESTIONS

Have you ever stretched an elastic band? When you pull it apart and then release it what happens?





*Wow, I wonder how far
I could shoot this elastic!*

When we stretch an elastic band, we store energy in it. This is because when the band is stretched it can do work when you release it. We are going to look at some other ways of using stretched elastic bands to do work and produce movement.

ACTIVITY: Making your own catapult

MATERIALS:

- 10 ice lolly sticks or craft sticks
- 4 to 6 rubber bands
- 1 plastic spoon
- Bag of marshmallows

INSTRUCTIONS:

1. Place 8 of the sticks together and tie a rubber band tightly around one end.
2. Tie another elastic band around the other end so that the sticks are bound tightly.

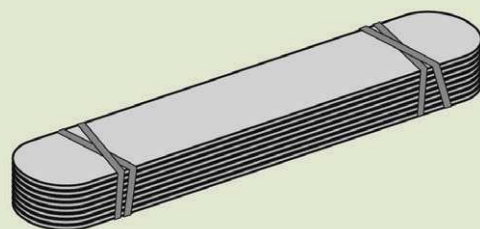

3. Tie a rubber band around the remaining 2 sticks, close to the one end.

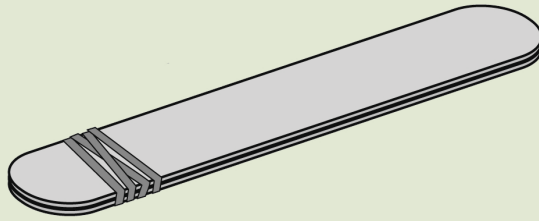

4. Insert the bundle of 8 sticks bound together through the 2 stick bundle. Look at the image below to see how to do this.

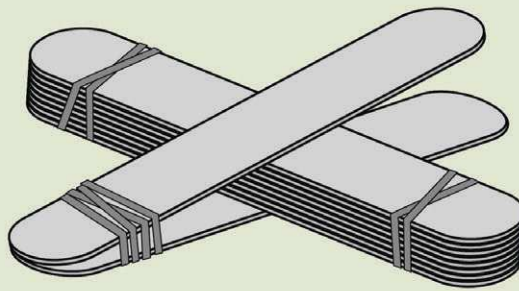

5. Tie another rubber band in a cross so that the two bundles are held in place, as shown below.

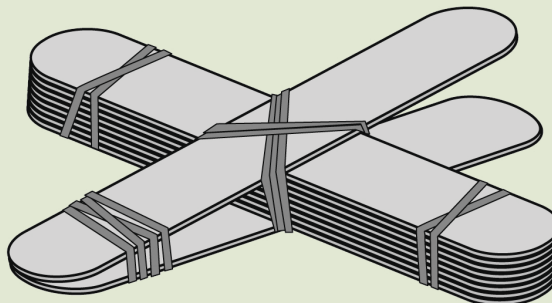

6. Use a rubber band to secure the plastic spoon on the end.
You now have a simple catapult.

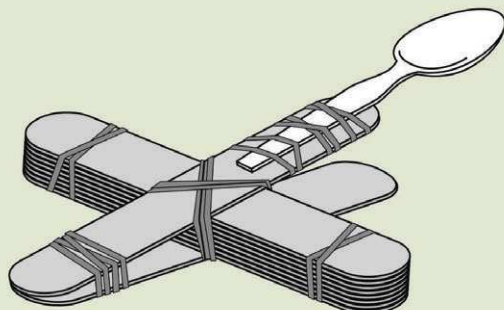

7. Shoot the marshmallows by placing one on the spoon, pulling down and then releasing it.
8. Have a competition to see who can shoot marshmallows the furthest and the most accurately - can you hit a target?!

QUESTIONS:

1. How are you able to shoot a marshmallow closer or further away?

2. When the marshmallow goes as far as possible, how much did the elastic band stretch compared to when the marshmallow did not go far?

3. Where did the movement energy of the marshmallow come from?

We saw in this activity that if you stretch an elastic band, you can produce movement. The stored energy in the band when it is stretched has the potential to do work. We call the stored energy in the elastic band potential energy because it has the potential to do something for us later. But what does the word potential mean?



QUESTIONS

Look up a definition for potential in your dictionary.

A stretched elastic band can also produce movement and do work in the future when it is released.

Let's look at another way of using an elastic band to produce movement energy. We are not going to stretch, but rather twist the elastic band.



ACTIVITY: Build an elastic powered boat

MATERIALS:

- rectangular wooden block (about 5 cm by 8 cm by 2 cm)
- 2 ice cream sticks
- 1 piece of plastic (6 cm by 2,5 cm cut from a plastic coffee tin lid)
- 1 large rubber band
- 1 small rubber band
- a tub of water to test your boat in

INSTRUCTIONS:

1. Secure the ice cream sticks flat against the sides of the wooden block with a thick rubber band, so that about $\frac{1}{4}$ to $\frac{1}{2}$ of each stick is extending out beyond the end of the block.

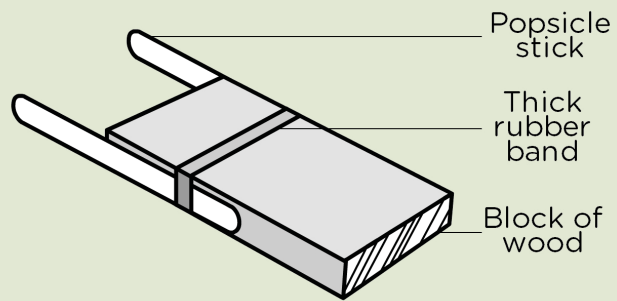

2. Place a thinner rubber band across the ends of the sticks.

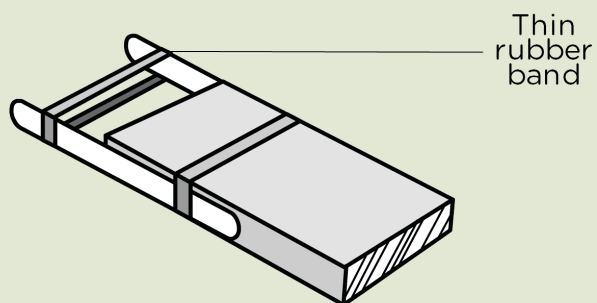

3. Slip the piece of plastic through the thin rubber band.

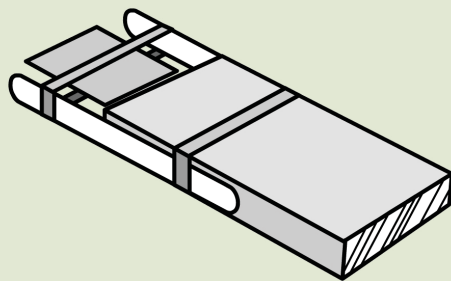

4. Turn the plastic to twist the rubber band.

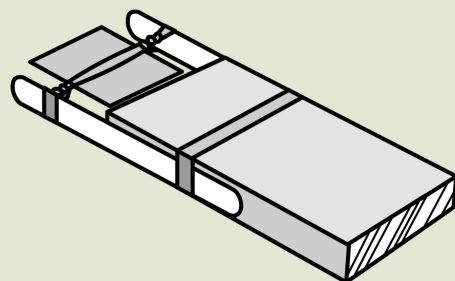

5. Place it in the water, and let it go.

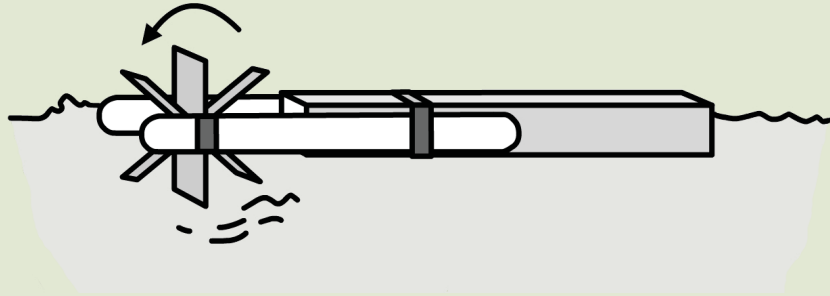

6. Challenge: Can you get your boat to move backwards and forwards?

QUESTIONS:

1. What is the purpose of twisting the elastic band?

2. Why does the boat go?

3. How could you make the boat go in different directions (backwards and forwards)?

4. Write down what you have learnt from the last two activities that you have completed.

We have been looking at elastic bands and how they can be stretched or twisted to store energy to do work (to produce movement). Springs can also be compressed or stretched to store energy.



A slinky is a spring.

A slinky is a metal coiled spring. When you stretch a slinky spring it stores energy. When the spring is released, the stored energy is changed into movement energy as it springs back into place.

Springs can also be compressed to do work. To compress something means that you squash it! Look at the photo below of a child jumping on a pogo stick. This pogo stick works using a compressed spring.

VISIT

Slow motion slinky spring (video).
goo.gl/FwIFL





This spring was stretched and when released it moves back.

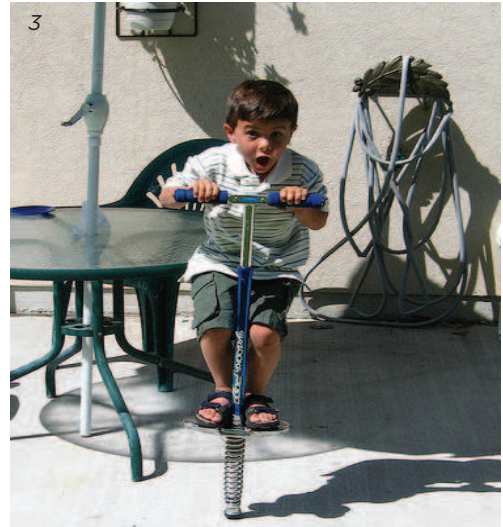

Jumping on a pogo stick.



QUESTIONS

Use your knowledge of springs to explain how a pogo stick works. Your answer must include the words compress, stored energy and movement.



KEY CONCEPTS

- Stored energy can be changed into movement energy
- Energy can be stored in a stretched or twisted elastic
- Energy can be stored in compressed or stretched springs

REVISION:

- 1. A jack in the box is a fun toy. An object jumps out of a box when the lid is opened. Explain how it works by using a spring.

- 2. A stretched elastic band is an example of stored/released energy?

- 3. What else, besides stretching, can you do to an elastic band to give it stored energy?

- 4. Think of some examples which you have experienced that use springs to store energy and write them down below.





KEY QUESTIONS

- What is a wheel and axle system?
- What is the purpose of using wheels and axles?
- How can I make my own wheel and axle system?

Have you ever looked underneath a car? It looks very complicated and there are all sorts of pieces and parts, each with their own job to do. We are going to focus on two of the main parts in a vehicle which allow it to move.

NEW WORDS

- axle
- machine



4.1 Wheels and axles

All vehicles have wheels. Most cars have 4 wheels, but some have a lot more, while other cars have only 3 wheels. Trucks and buses have many wheels while some trailers or bicycles only have 2 wheels.

QUESTIONS

Why do you think wheels are round? Why will a square or a triangular wheel not work?



How did wheels and axles develop?

In the past, before the wheel was invented, it was very difficult to move things around. People would try to drag heavy things along the ground using ropes, or else they had to carry things. But this was very inefficient! So people started to experiment with ways of making it easier to transport goods and heavy objects.

The pyramids in Egypt were built long before trucks and modern transport were invented.



The pyramids are very high structures made of stone.

The Egyptians were very clever in finding ways to move very heavy objects. They used logs that were laid down like in the picture. The heavy objects were placed on them, rolling them creating movement like in the picture.

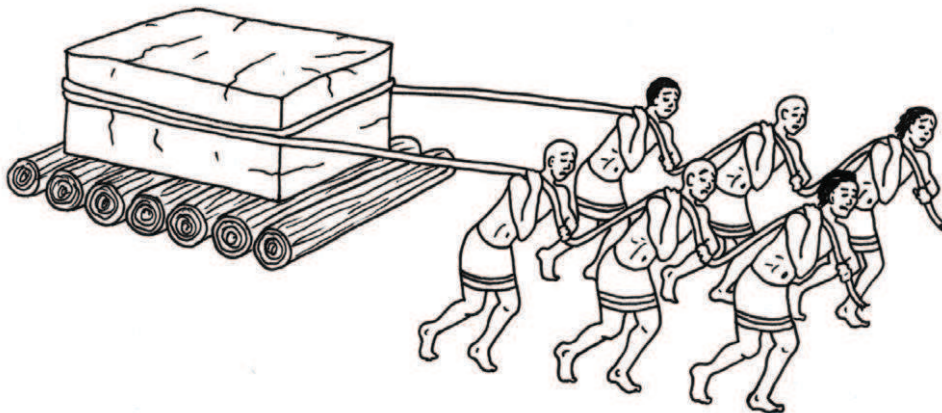

Egyptians pulling heavy stone blocks along logs.

The Egyptians used this method to move the massive blocks of stone to build their pyramids. But, there were still many problems with using logs cut from trees.



QUESTIONS

Can you think of some of the problems of using logs to try to move very heavy objects? Discuss with your friends around you and write your answers below.

DID YOU KNOW?

The first inflatable tire was made of leather. Today they are made from rubber.



Later on, people then started to cut the logs into short pieces so that they were the same size. It was like a wooden disc. But the wooden disc could not stand up by itself so people attached a wooden pole between two of the wooden discs. This was the axle that is still used nowadays. This is how the first wheel and axle were developed!

People could then balance goods on the axle and use this simple machine to pull or push objects along. But this wheel was still very heavy! To make it lighter, the wheel was changed to a round frame with spokes, like a wagon wheel. This made it much lighter and easier to move. Since then, the wheel has advanced a lot. Think of the shiny metal and rubber wheels you see on cars today!

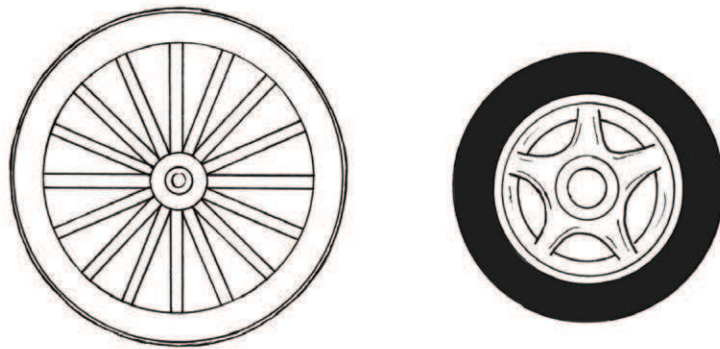

A wagon wheel and the modern rubber and metal rimmed wheels we have today.

VISIT

Wheels and axles
(video).
goo.gl/LAvza



How do wheels and axles help us?

A wheel and axle is a simple machine. A machine is used to make it easier to move a load.



It is much easier to move a heavy bag on a wheelbarrow than to carry it by hand.

DID YOU KNOW?

The earliest record of a wheelbarrow comes from China in the Three Kingdoms period (AD 184-280).



A wheel and axle is made up of a wheel (large cylinder) joined onto an axle (which is a small cylinder).

QUESTIONS

Label the two wheels and the axle in the following diagram.

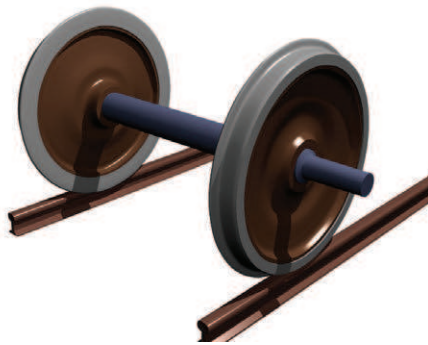

Wheels and axle. ²



When we think of wheels and axles, we think of cars and other vehicles that we see all around us that have wheels.



A wagon wheel and axle.

However, there are many examples of machines that use wheels and axles:

1. rolling pin
2. windmill
3. fan
4. egg beater
5. door knob
6. bicycle wheels



ACTIVITY: Identifying vehicles with wheels

1. Find pictures of three of the above examples. Look in old magazines and newspapers at home, or on the internet for pictures. Paste the pictures in below and label the axle and the wheel in each picture.

A large, empty rectangular box with a thin black border, intended for students to paste their findings and label the axle and wheel in each picture.

2. Explain carefully how a door knob is a wheel and axle machine.

Let's make a simple wheel and axle mechanism to understand how it works.

ACTIVITY: A simple wheel and axle machine

MATERIALS:

- 2 chairs
- broom handle
- string
- bucket with handle
- masking tape
- scissors
- ruler



INSTRUCTIONS:

1. Place the chairs back to back, about 30 cm apart. Rest the broom handle across the back of the chairs.
2. Tie a 50 cm length of string to the bucket handle.
3. Tape the free end of the string to the middle of the broom handle.
4. Place a few marbles or some other light objects in the bucket.
5. Turn the broom handle with your hands to raise the bucket into the air. Turn it back the other way to return the bucket to the ground.
6. Tape the ruler straight up and down the broom handle near one end.

7. Use the ruler, which acts as a wheel, to turn the broom handle and lift the pail.

QUESTIONS:

1. Could you lift the bucket by turning the broom handle with your hands?

2. Was it easier to lift the bucket when you turned the broom handle using the ruler?

3. Replace the ruler with a stick that is longer than the ruler and use the stick to turn the broom. Was it easier to lift the bucket using the long stick?

4. Identify the axle in the setup.

5. Identify the wheel in the setup

6. Write a conclusion to summarize what you learnt in this activity.

Now, let's put two axles and four wheels together to make a simple tractor!

ACTIVITY: Making a tractor with wheels and axles

MATERIALS:

- cardboard
- two pencils
- a small box
- scissors

INSTRUCTIONS:

1. Cut out four circles of the same size from the cardboard. You can use a lid from a bottle or a cup to trace around to get circles which are all the same.
2. Make a hole in the centre of each circle and in the bottom 4 corners of your box.
 - a. To find the centre of the wheel draw diameter lines across the middle.
 - b. A diameter line is the longest straight line you can draw across a circle. Where diameters cross, that is the centre.

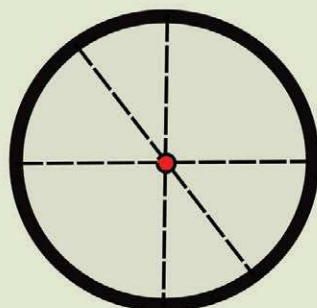

A wheel is a circle. Find the centre by drawing some diameters. In this example the centre is the red dot.

3. Push a pencil through the middle of one circle and through a corner of the box.
4. Push the pencil through to the other hole on the other side of the box.

5. Then attach another circle on the end of the pencil poking out of the side of the box.
6. Repeat this for the other 2 wheels.
7. You now have a simple tractor like in the picture below.
8. Put an object in the box and push your vehicle along the floor.

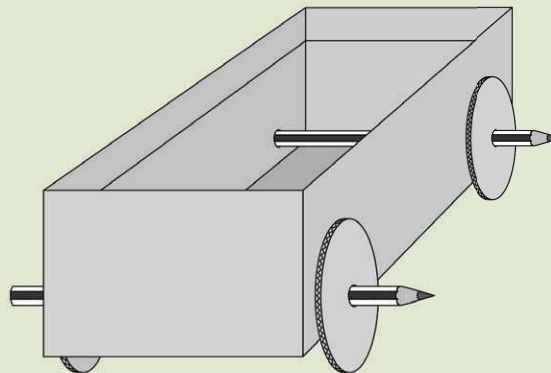

QUESTIONS:

1. Can you see the wheels turning on the axles and how the axles connect the wheels?

2. Which part of the vehicle that you made is the axle?

Different ways to make wheels and axles

We are now going to experiment with different ways of making wheels and axles and finding out the best materials to use.

There are two ways to let wheels turn on an axle. One way is to have the axle fixed to the body, and the wheels are free to turn on the axle. The other way is to have the wheels fixed to the axle and the axle turns in a bigger tube called the bearing. The bearing is the hollow tube that the axle goes through. The bearing must be bigger than the axle so that the axle can turn easily.

You can use plastic straws or the barrel of an old ball-point pen to make a bearing for an axle. The picture shows you two ways to fix the bearings onto the body.

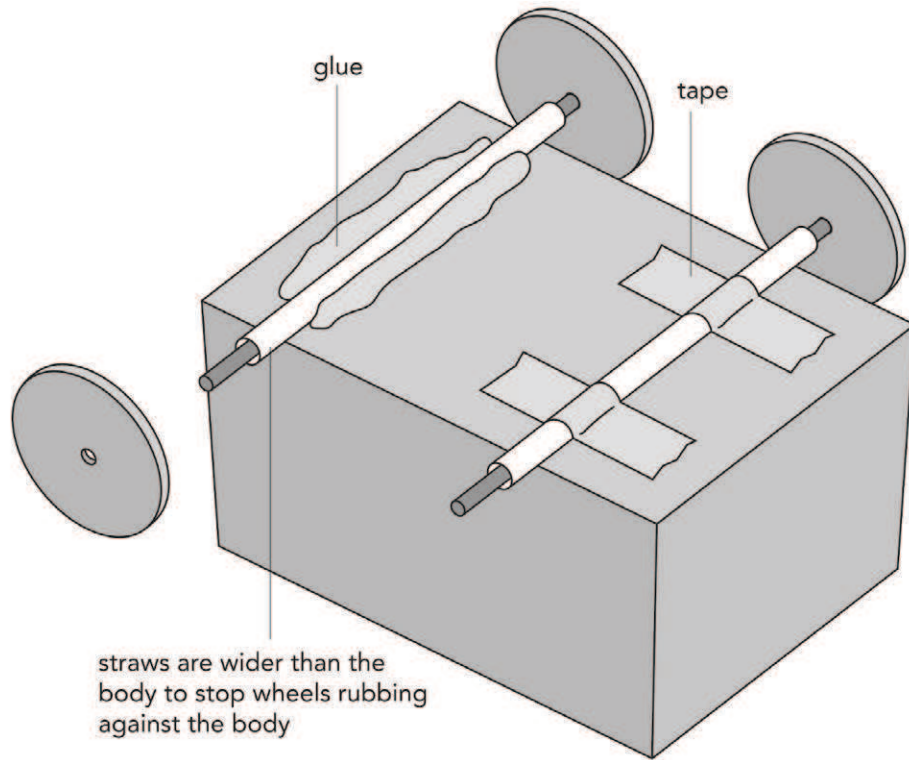

Two ways to fix the bearing onto the body.

QUESTIONS

1. What are the two ways used in the picture to fix the bearing onto the body.

2. What are some materials that you could use to make the axle in the above picture?



You can also use plastic sign-board or strong corrugated cardboard to make a body with wheels. Can you see how the axle goes through the holes in the cardboard?

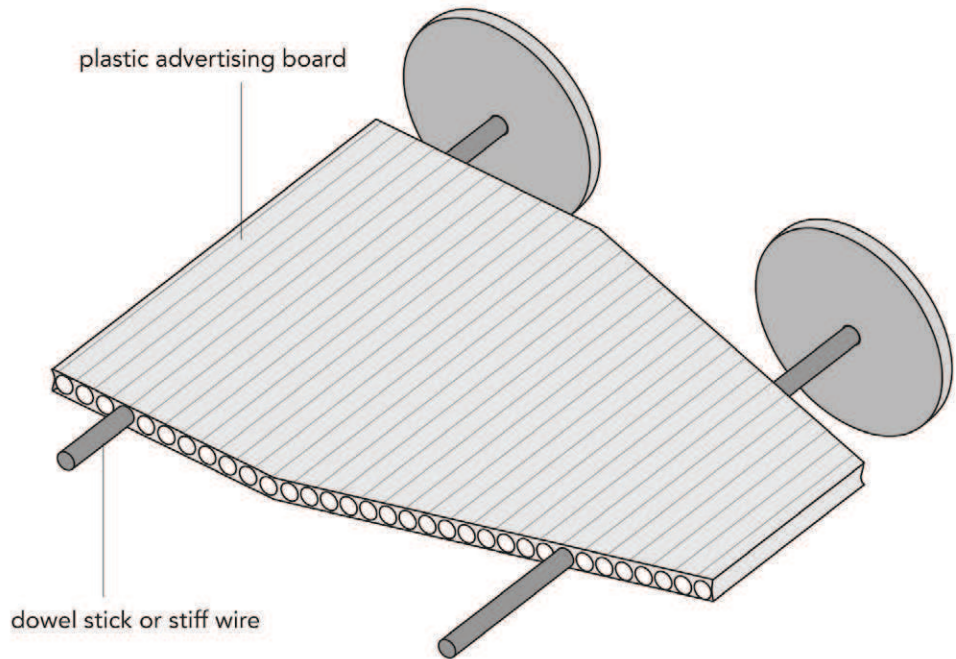

The board makes bearings for the axles which are fixed to the wheels. The axles turn in the holes.

The next picture shows you the other way to let the wheels turn. This time the axle remains still and the wheels turn on the axle. The axle is fastened to a wooden body with cable clips. Cable clips fasten telephone cables to walls. Can you see the blown up version of a cable clip? The clips may hold the axle tightly, so the wheels must be free to rotate.

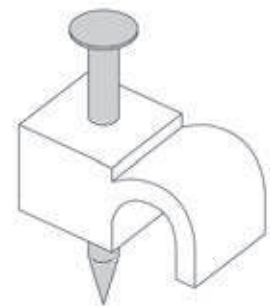
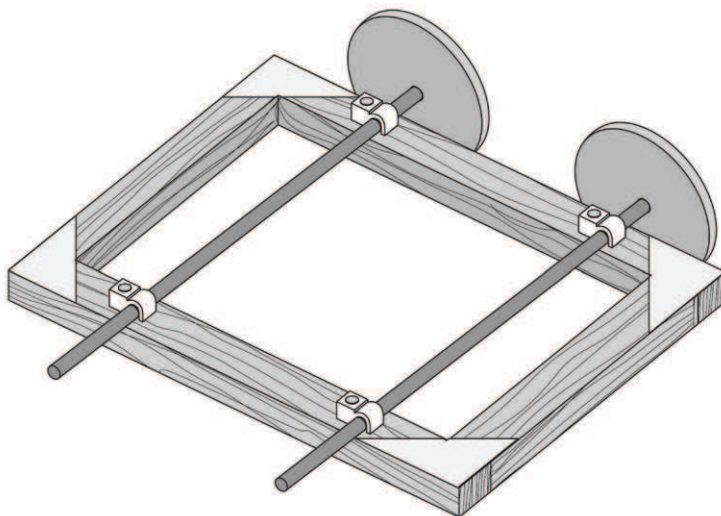

A clip to hold telephone cables to the wall.

How the cable clips can hold an axle.

ACTIVITY: Making and evaluating different wheels and axles.

MATERIALS:

- things to collect for wheels: shoe-polish tins, the lids of bottles, cut out cardboard circles.
- things to collect for axles: sosatie sticks, stiff plastic straws, wooden dowel sticks, aluminium rods, nails or wire, or the school may have plastic rods from a supplier.
- scissors
- glue
- tape
- pencils and crayons
- a small box



cardboard circles

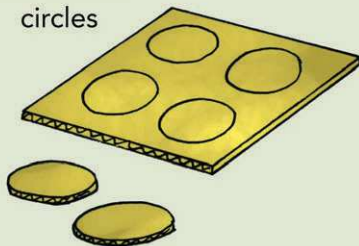

snuff boxes



lids of jars



plastic straws

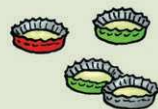

bottle-tops



plastic rods

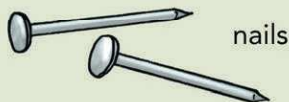

nails



wooden dowels

Things you can use for wheels and axles.

INSTRUCTIONS:

1. Bring the different materials that you have collected for wheels and axles to class.

2. You must now experiment with the different materials that you have to make wheels and axles. Attach the setup to the small box to test the wheels and axles.
3. Remember what you learned about how to attach axles to the box and experiment with these different methods as well (Hint: Bearings!)
4. Experiment with different sized wheels and find the best option.
5. Once you have tested and evaluated the different setups you have made to see whether they move easily, select the best option and make an improved tractor from the simple tractor you made at the beginning of this chapter with the pencils.
6. Evaluate how far your improved tractor can go if you give it a push with an object in the small box.

QUESTIONS:

1. Do a drawing of your final design for your improved tractor below. Remember to label the different materials that you used.



2. What did you decide was the best material to use for the wheels and why?

3. What did you decide to use for the axles and why?

4. How did you attach the wheels to the axle in your final design?

5. How far could your tractor go after you gave it a push and it was carrying an object?

6. How would you improve your design if you had to do it again?



KEY CONCEPTS

- Many vehicles are systems that use wheels and axles
- Wheels and axles are used to help vehicles move more easily

REVISION:

1. List four different vehicles which make use of wheels and axles in order to move.

2. When Jojo was experimenting with making wheels, he decided to use bottle lids. Look at the picture below. He decided that glueing two lids together was better than one lid. Explain why you think Jojo did this.

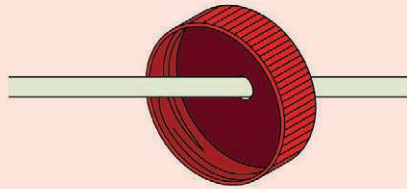

Jojo glued two lids together.

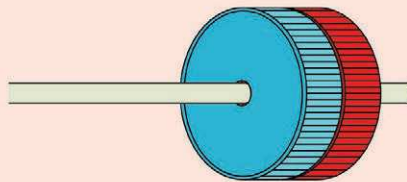

3. When Jojo made the axles for his tractor, it looked like this underneath:

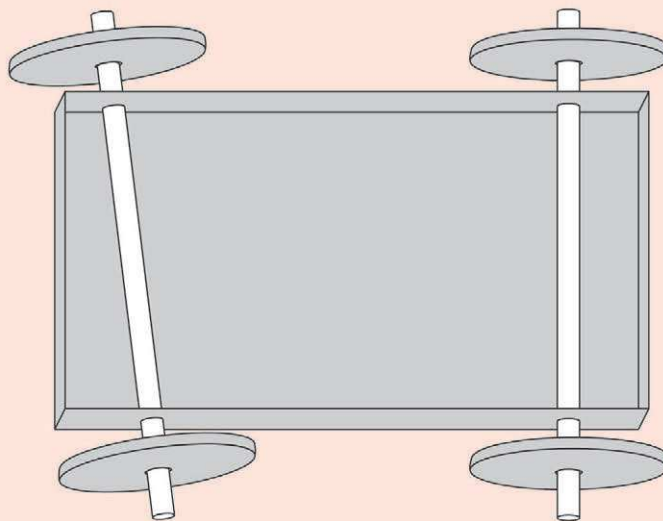

The axles under Jojo's tractor.



What is wrong with these axles and how do you think the tractor will move? What should Jojo do to improve his design?

4. When looking to buy a pram, there are many different ones available. Some have big wheels and some have small wheels. Look at the pictures below.



This pram has small wheels.



This pram has big wheels.

When do you think it would be best to use a pram with small wheels and when would a pram with big wheels be used?

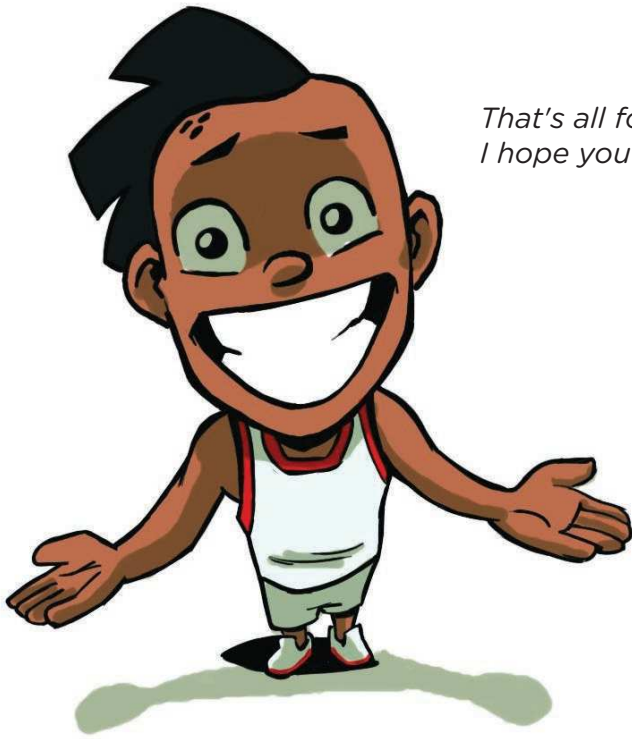

*That's all for Energy and Change!
I hope you enjoyed it as I sure did!*





**Earth and Beyond
and Systems and Control**



KEY QUESTIONS

- Why does the Sun appear to move across the sky?
- How long does it take the Earth to move around the Sun?
- How long does it take the Earth to spin around once on its axis?

1.1 The Earth moves

In Grade 4 we learnt that the Earth moves in two different ways. The Earth orbits the Sun and the Earth also spins on its own axis. Let's revise these concepts again.

NEW WORDS

- orbit
- axis
- space
- planet
- circle
- path
- plane
- diameter
- kilometre (km)

The Earth spins around, and so we have day and night

In Grade 4 you learned that the Earth spins on its axis. But what does this mean? Imagine an orange with a pencil stuck through it. Look at the picture. If you hold the pencil in your fingers, you can spin the orange around. The pencil is the axis of the orange.

The Earth does not really have a pencil through it, but it does spin around. We can imagine a big pencil through the middle of the Earth.

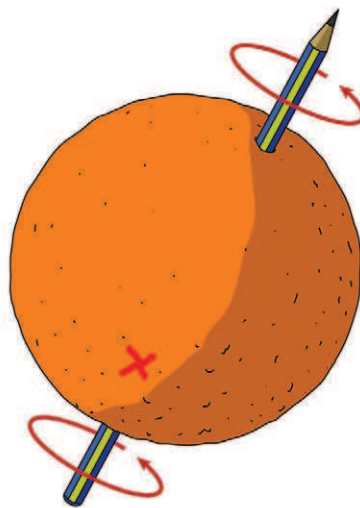

The Earth is like the orange and the pencil is like the axis. The curved arrows show which way the Earth spins.

We are on the Earth. Let us imagine we are at the point where you see the red "X" on the orange on the previous page:

- The Sun shines on the Earth and so we, at **X**, see the Sun. We call that day-time.
- But the Earth never stops spinning. So we, at **X**, move around into the shaded part of the Earth. Then we cannot see the Sun any longer and it is night-time for us at **X**.
- The Earth spins right around in 24 hours, so it will take 24 hours for us to come around to the same position you see in the picture.
- We call the 24 hours a day. When we say "a day" we really mean a day-and-night; together they last 24 hours.

VISIT

Planet Earth (video).
goo.gl/aqaDr



If we are at position **X**, we move past the Sun. But to us, it looks as if the Sun is moving. The Sun seems to move from the East to the West. In the East it rises (= comes up) goes across the sky at lunch-time and moves to the West where it sets (= goes down). But the Sun does not actually move.

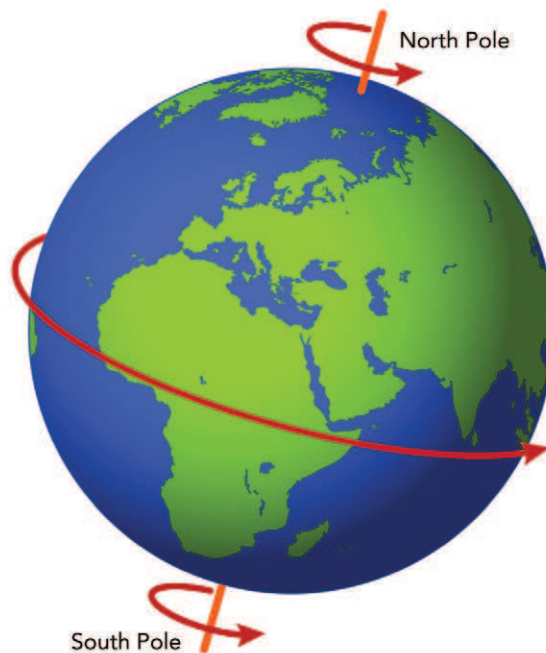

The Earth has an axis from the North to the South pole.



ACTIVITY: Who is having daytime?

What you need

- the classroom globe of the Earth
- the photographs of the Earth below



This is a classroom globe. A globe is a model of the Earth.

INSTRUCTIONS:

1. There are two images of the Earth.
2. Look carefully at these pictures and use them and the globe to answer the questions.



Picture A.



Picture B.

QUESTIONS:

Picture A

1. You are in South Africa. Find South Africa on the globe. Find South Africa in **Picture A**.
 2. Was it daytime in South Africa, when the spacecraft took the photo?
-

3. Was it daytime in Saudi Arabia? Hint: Use your globe to find Saudi Arabia and then find it in **Picture A** to see if it is day or night.
-

4. Was it day time in Argentina when this photograph was taken? Use the globe to help you locate Argentina. Explain your answer.
-
-

5. The tip of Brazil is in the sun in Picture A. Is it morning or afternoon in Brazil? Why?
-
-

Picture B

1. Look at Picture B. What part of the Earth is this picture showing?
-

2. Can you see the lights on in Italy? When it is dark in Italy, is it still light in Spain?

3. Is it late afternoon or morning in Spain in Picture B?

Now that we have looked at some photographs of the Earth as it changes from day into night as the Earth rotates, let's make a model of Earth using our heads to explain this.



ACTIVITY: Your head can be a model of the Earth

MATERIALS:

- yourself
- sunlight coming from one side

INSTRUCTIONS:

1. This model will help you to understand why we see the Sun move across the sky. Do this in the early morning when the Sun is still low.
2. We will say that your nose is Africa. You are on Africa. Look at picture below.

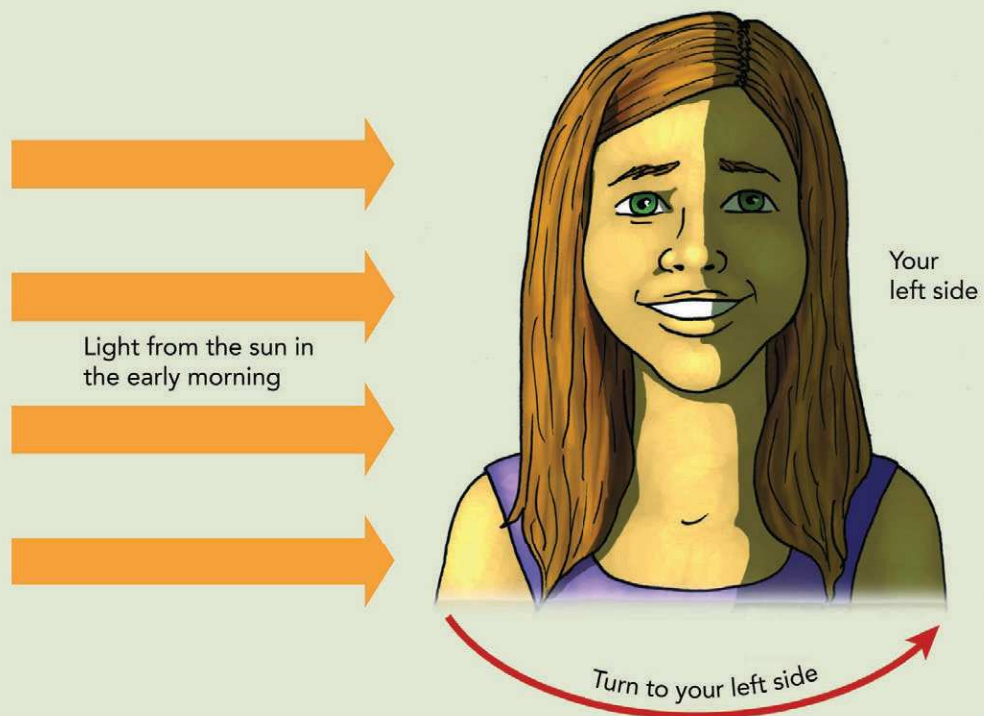

Using your head as a model of the Earth.

1. Now stand so that bright light from the Sun shines across your right cheek.
2. Turn slowly to your **left**. Turn your eyes towards the bright place where the Sun is. You will see the Sun move to your right while you move to the left.
3. Move your feet and turn further; you will see the Sun "go down" over your right cheek.
4. When you have turned your back to the Sun, you cannot see the bright light any more. That is like night-time in Africa.
5. Turn further to your left and you will see the Sun "rise" over your left cheek. That is like sunrise in Africa.

QUESTIONS:

1. Which of your cheeks is like the west? That is where the Sun appear to go down.
-

2. Which cheek is like the east, where the Sun appears to come up?
-

We see the Sun rise and move across the sky every day. But the Sun does not really move; it only seems to move. Earth is spinning round and round, and we are moving around with the Earth. The Earth takes 24 hours to complete one full rotation.

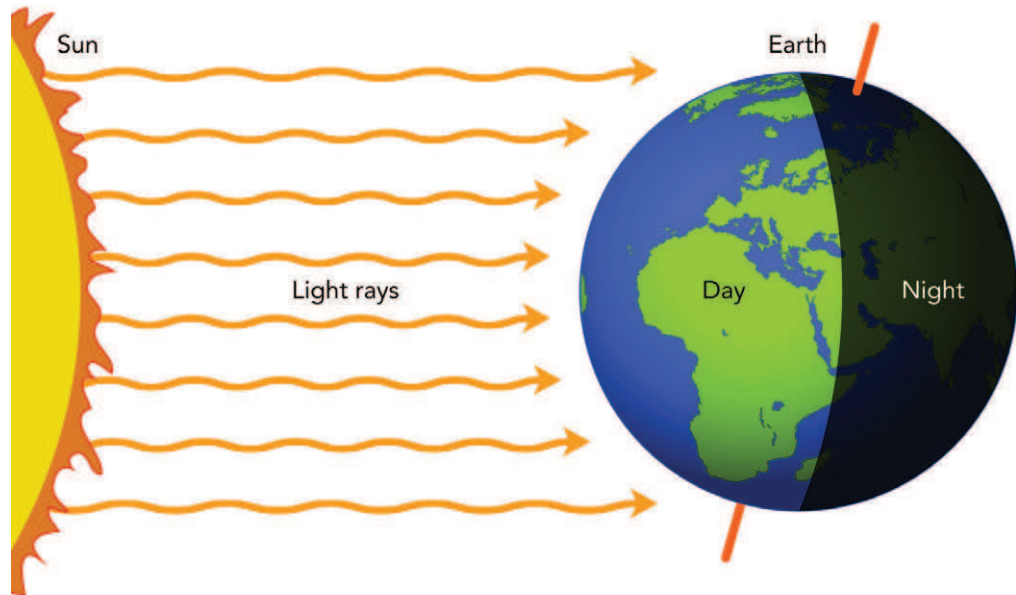

Can you see how the light from the sun only reaches one half of the Earth as it rotates?

The Earth moves in an orbit around the Sun

The Earth moves around the Sun. The Earth moves around the Sun while it is spinning. It spins round 365 times while it completes one orbit of the Sun. That means 365 days pass and we call that a year.

The Earth is called a planet. There are 7 other planets also moving around the Sun. You can see one of the other planets on most evenings, or early in the morning. This planet is called Venus or *iKhwezi* or *Naledi ya Masa*. It is not a star.

VISIT

Short video showing the Sun, Earth and moon system.
goo.gl/cXeog



You can see the planet Venus just after sunset or just before sunrise below the moon.

Venus also moves around the Sun but its orbit is a smaller circle

than Earth's orbit. Venus takes 225 Earth days to go once around the Sun.

Mars is another planet you can see on some nights. Mars appears as a small, orange dot in the sky. Mars takes 687 Earth days to go once around the Sun.

You can also see Mercury, Jupiter and Saturn in the sky, but they are harder to see than Venus and Mars. All the planets seem to move along the same path that the Sun and Moon seem to move.

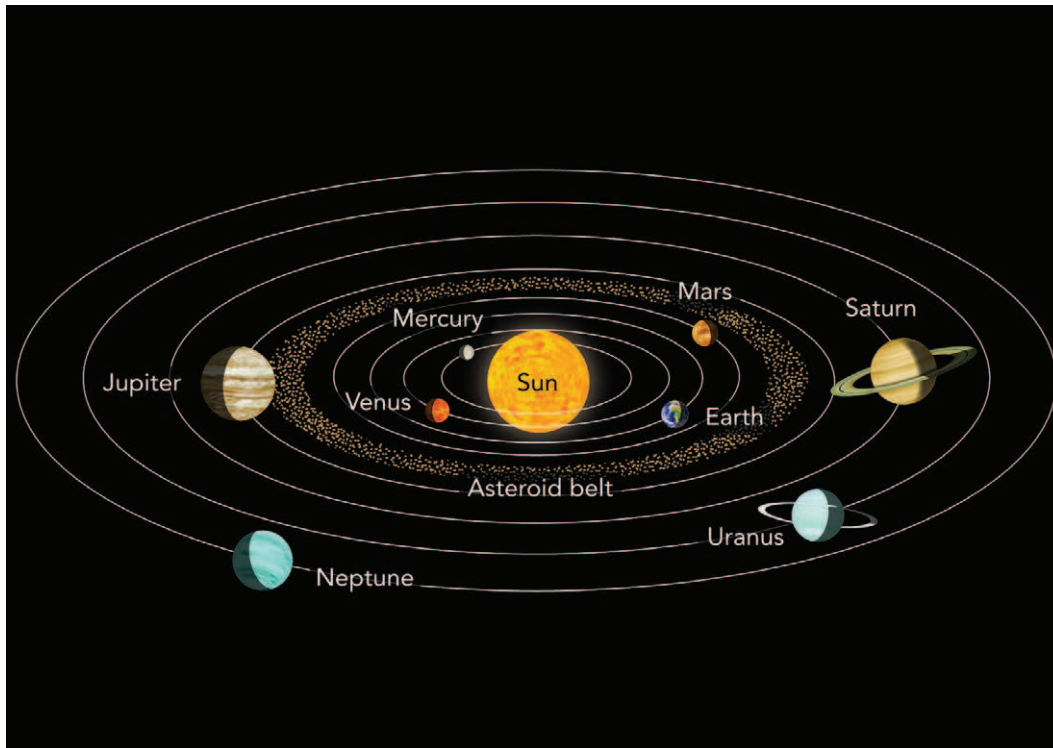

The planets move in orbits around the Sun. The orbits lie on the same plane, as if they were on a big flat plate.

The orbits of the outer planets are actually much bigger than what is shown in this image. But, if we tried to draw the orbits to scale, they definitely would not fit on this page!

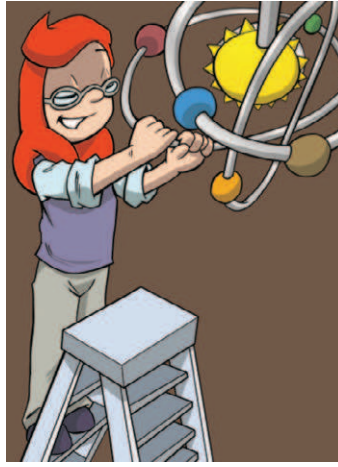

My model of the solar system is not to scale. If we want to make one to scale, we will need a really big area!

Let's make a scale model of the solar system using our bodies to understand what it means to orbit the sun!



ACTIVITY: A scale model of the solar system

MATERIALS:

- 100m heavy string
- 9 pieces of heavy cardboard
- scissors
- permanent marker

INSTRUCTIONS:

1. Learners are divided up into 8 groups and each group is assigned a planet.
2. Each group must cut a piece of string to represent the distance of their planet from the sun, using the lengths indicated in the table below. The actual distance of the planets from the Sun is given in gigameters (Gm) and the length of the string is in meters (m).
1 gigameter is 1 million kilometers is 1000000000 meters.

Planet	Distance from Sun (millions of km)	Length of string (m)
Mercury	58	0.4
Venus	108	0.7
Earth	150	1.0
Mars	228	1.5
Jupiter	779	5.2
Saturn	1 434	9.6
Uranus	2 873	19.2
Neptune	4 495	30.0

3. Each group must cut a circle out of the cardboard and write the name of their planet and the actual distance from the Sun on it.
4. Make a hole at one edge of the cardboard and tie the length of string to it.
5. Now it is time to go outside to a big open space, like the school field!
6. Your teacher will be the Sun in the centre. She does not move as the Sun does not move.
7. One member from each group must hand the "Sun" the end of their length of string and then stretch out their length of string.
8. Do this one at a time starting from Mercury and going out to Neptune. You do not all need to be in a straight line but can be in different positions around the "Sun".
9. Place the strings on the ground, all stretched out in different directions.
10. Walk around so that you can all see the scale model of the solar system.
11. Now comes the tricky part - making the planets orbit the Sun.
12. Select one learner from each group to be the planet.

13. He/she must pick up the planet and walk in a circle around your teacher, all going in the same direction. Try and walk at the same speed.
14. Swop with other learners in your group so that you each have a turn to be a planet orbiting the Sun.



KEY CONCEPTS

- The Earth spins on its axis. This is the reason we have day and night.
- The Earth also moves through Space, around the Sun.
- The Earth's path through Space around the Sun is called its orbit.

REVISION:

1. How many hours are there in a day?

2. How many hours pass from sunrise until the next sunrise?

3. How many days pass between your 10th birthday and your 11th birthday?

4. How many times must the Earth spin around between your birthdays?

5. Which planets have smaller orbits than Earth?

6. Write out the whole paragraph and complete it.

Use some of these words to complete the sentences. You do not need all the words.

- the orbit of Mars
- the orbit of the Earth
- 687 Earth days
- 365 days
- Sun

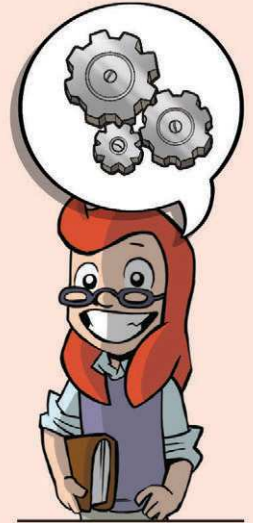

- Earth

If I lived on Mars, I would have to wait much longer for my birthday. The reason is that _____ is much bigger than _____, and Mars takes _____ to go around the _____ once.



*Let's now find out
more about our
planet Earth.*



KEY QUESTIONS

- What would you find if you could dig a very deep hole?
- Where does soil come from?
- If you were going to buy a farm, what kind of soil would you look for?

2.1 Rocks



QUESTIONS

1. You saw the photo of the Earth at the beginning of Chapter 1. What is on the surface of the Earth? Name all the features (parts) you can think of.

2. What do you think is under the surface?

NEW WORDS

- crust
- mantle
- core
- model



ACTIVITY: What will you find if you dig a hole, as deep as it can go?

Look at the picture of a digging machine and imagine you are driving it.

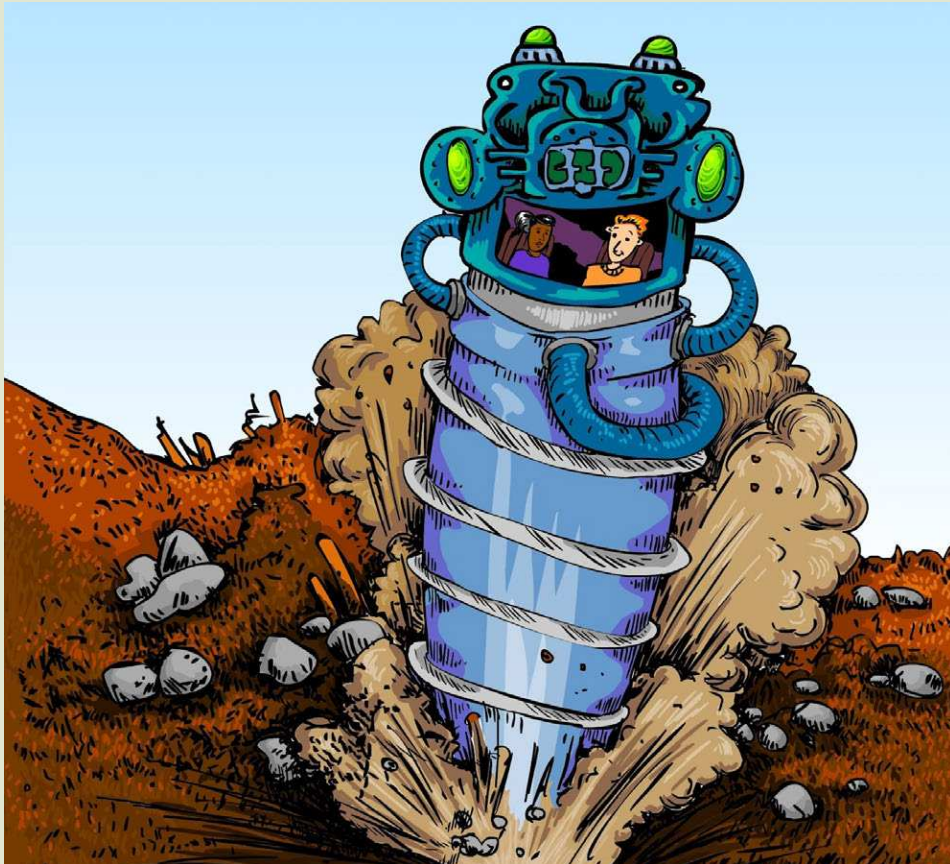

Imagine that you have a powerful digging machine

QUESTIONS:

1. What is under the floor of this classroom?

2. Imagine that you use the machine to dig as deep as you want. You drive it down into the Earth. What do you find as you go down?

DID YOU KNOW?

Geomorphology is the study of the Earth's surface features.



-
-
3. Do a drawing of yourself, the digging machine and the hole. In your drawing, show (a) the Earth (b) the digging machine with you inside (c) the hole (d) what you find at the deepest part of the hole.

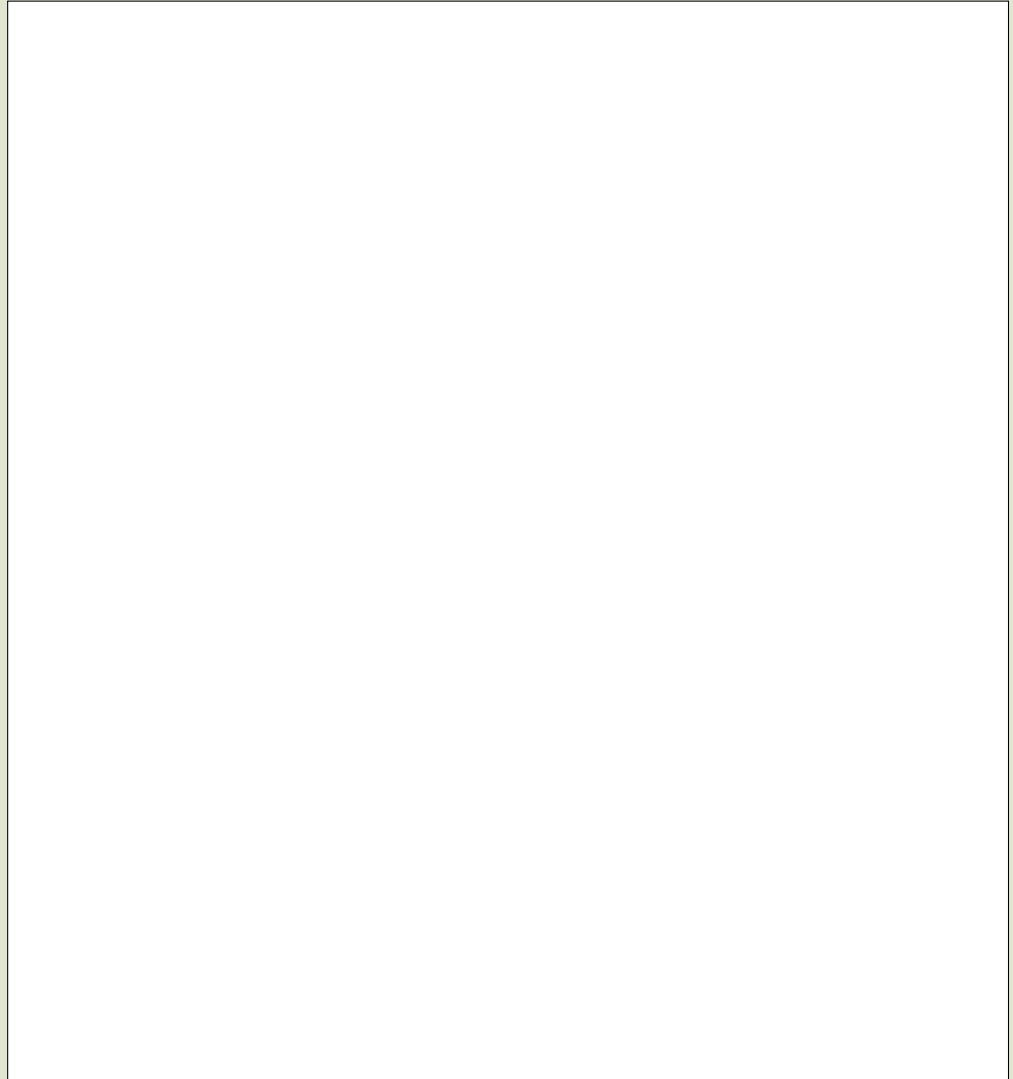

DID YOU KNOW?

The deepest mines in the world are in South Africa, in Gauteng. Those mines are 4 kilometres deep and the miners are digging deeper every month.



So what do we find as we dig deeper?

When we begin to dig, we first dig through topsoil. Good topsoil is usually a dark colour.

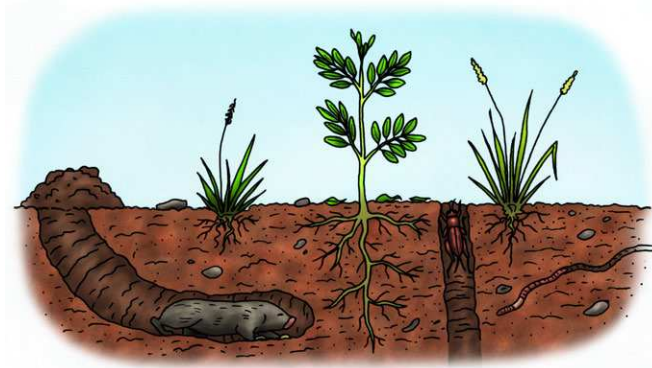
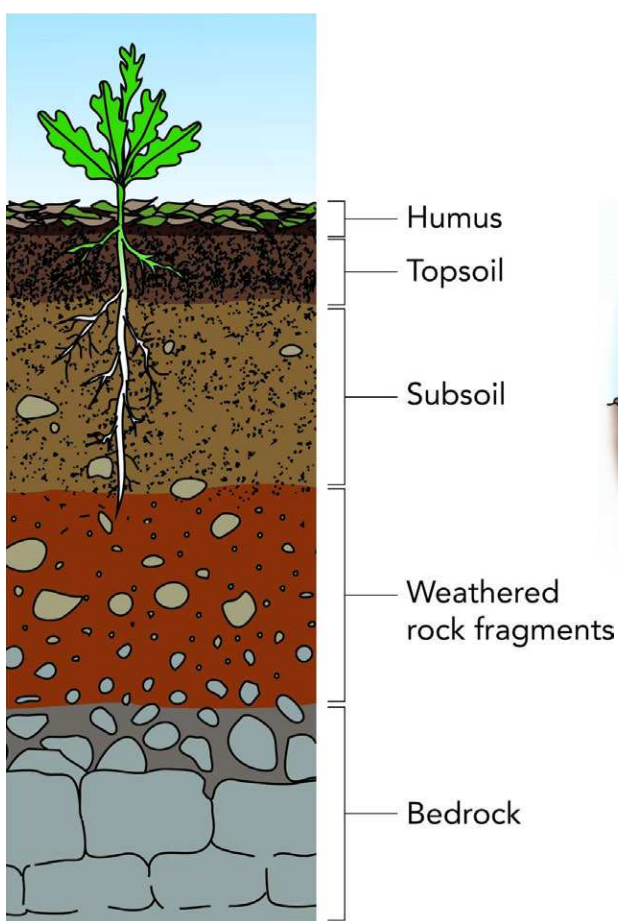

Plants and animals depend on topsoil.

Topsoil is usually darker than the soil underneath.

Topsoil is very important for life. As you can see in the picture, plants and animals depend on topsoil.

If we dig deeper, we find subsoil. This layer is often sandy and orange in colour. When we dig deeper, we come to rock. This layer of rock underneath the soil is called bedrock. Look at the illustration and find the topsoil. Find the subsoil underneath the topsoil and the bedrock at the bottom.

When we dig through the rock, a few hundred metres deep, we may find different layers of rock. We may even find water in cracks in the rock in some places. We may find coal in a few places.

Deeper down, about a kilometre deep, we may find oil and gas. Still deeper, we will find very hard rock and the rock will feel hot to touch. In Gauteng and the Free State, in a very few places, we will find rock that has gold in it. Look at the picture below. Can you see a hand cutting a slice out of the Earth?

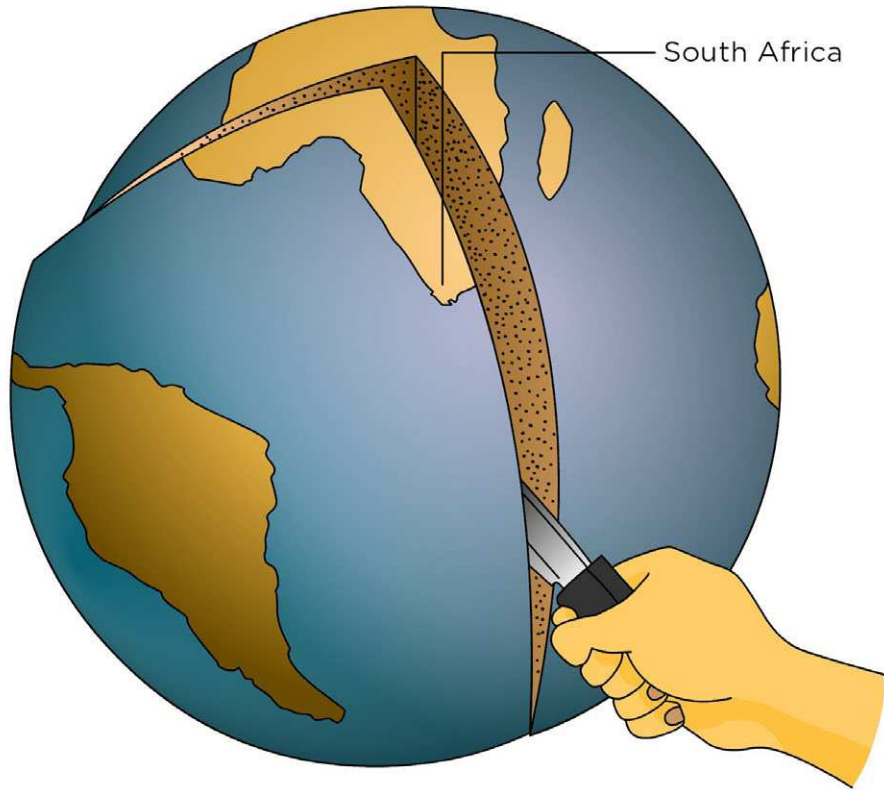

Imagine we could cut a slice out of the Earth.

In the next picture you see what the Earth is like inside.

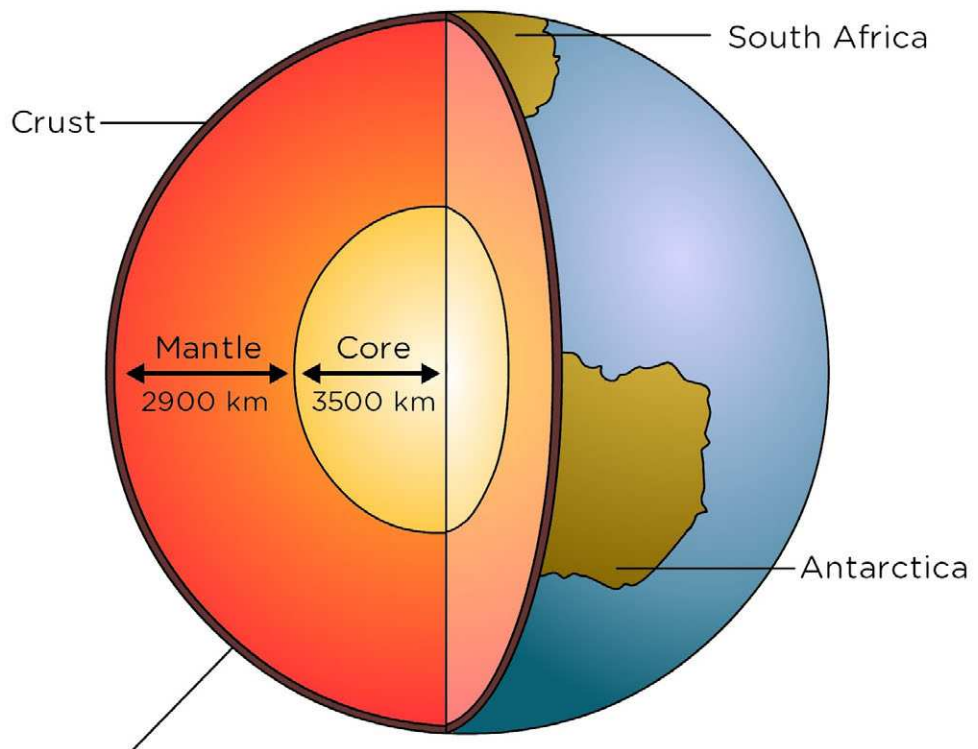

The crust may be 10 km thick under an ocean, but up to 70 km thick under a continent.

If we cut the slice out of the Earth, the Earth could look like this inside.

The surface of the Earth is the crust

People have not really gone very deep into the Earth. We are in rock that is called the crust of the Earth. The crust is the outer layer of the Earth's surface. Find the crust in the previous picture. The crust consists of rock and soil.

The crust is about 70 km thick, so we have not gone very far yet. Humans have only gone 5 kilometres deep, and the hole is so small that you can not see it in the crust.

VISIT

Video showing the structure of the Earth
goo.gl/YXUFE



Miners in the deep gold mines suffer from heat. The deeper they go, the hotter the rock is. ¹

Does the crust go under the sea also? Look at the picture of the rocks and sea in this picture below.



This is where the ocean meets the land. Does the land go under the ocean?



QUESTIONS

1. If you dig a hole in the beach sand what will you find if you dig very deep?

2. If you went down under the sea water, what would you find down there?

It must be such an interesting world in the depths of the oceans. I wonder what it is like?!



The sea is very deep if you go far from the beach. The sea may be kilometres deep.

The deepest part of the sea is called the Marianas Trench. It is near the Marianas Islands, south of Japan. You can find this place on the classroom globe or a map. The deepest part of the oceans is here. It is a trench (like a valley with steep sides) that is 11 kilometres deep. The Sun's light cannot reach down to the bottom and it is pitch-dark. The water presses down with a pressure that is like the weight of three buses pressing on your thumbnail!

Three scientists have gone down there in small submarines, and taken pictures and collected rocks. The submarines had bright lights, and the scientists were amazed when they saw animals that live down there. You can see an animal called an anemone in the picture.



The people in the submarines saw anemones like this in the deepest part of the ocean. ³

They found rocks that look like those in the photograph. So the crust rock lies under the oceans as well as under our feet. The crust is a layer of rock all around the Earth, like the shell of a hard-boiled egg.

The mantle and the core lie even deeper under the crust.

If we go deeper than the crust, we go into rock called the **mantle**. The mantle is the layer that lies underneath the crust. Mantle rock is much hotter than the rock that is found in the crust. The rocks are so hot that they are soft in some places, like toothpaste. If there is a weak spot in the crust, the hot rock pushes upwards and it might burst out. This is how volcanoes happen. The mantle is 2 900 km thick, so we still have a long way to go down.

QUESTIONS

Find the mantle in the diagram of the Earth cut open. Mark it with your pencil. How could you get to the mantle? Which way do you have to go?



The core is still deeper than the mantle. It is very hot, as hot as the surface of the Sun, and made of mostly iron.



ACTIVITY: Thinking about the layers of the Earth.

QUESTIONS:

1. What is the diameter of the Earth?

2. The Earth is really a ball, so how deep can the hole be?

3. If the digging machine went as far as it can go, what is the last layer of the Earth that it would dig through?

4. Which is the best **model** of the Earth - a loaf of bread, an apple or an avocado? Look at the three pictures below. Which of those is most like the Earth? Explain your answer. Remember that the Earth has a **hard crust**, a **hot sticky mantle** and a **hot core**.

A cross-section of a loaf

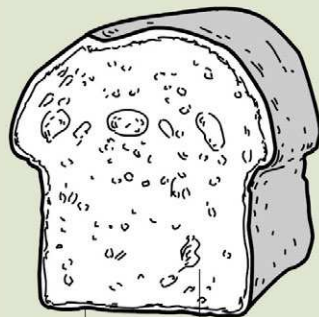

Crust

Soft part inside

A cross-section of an apple

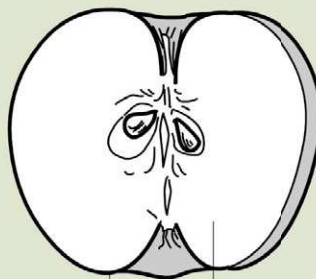

Skin

Flesh

A cross-section of an avocado

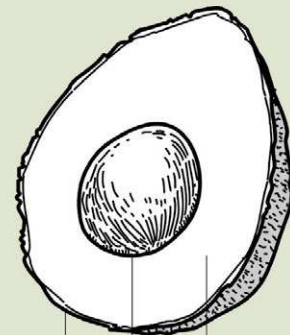

Hard skin

Pip

Soft flesh

Three different possible models of the layers of Earth.

5. Although the model you chose is most like the Earth, it is not exactly the same. In what way is this model not like the Earth?

Soil, air, water and sunlight support life on Earth

Life on Earth exists on the very thin layer around the planet - the crust. The soil is a thin layer and all the plants need soil to grow in. The plants use energy from the Sun to grow and they make the oxygen we and all the animals need to breathe. You already learnt about this in Life and Living.

ACTIVITY: So what is under our feet?

INSTRUCTIONS:

1. In the first activity at the beginning of this Chapter you drew pictures of yourself digging a hole into the Earth. You had to imagine you were making the hole as deep as a hole can be.
2. Perhaps you feel your picture is correct, or perhaps you want to change your idea about the Earth.
3. Look at those pictures now, and do the activity again.



QUESTIONS:

1. If you could make a hole into the Earth, through the floor of your classroom, what would you find down in the Earth?

2. Imagine you have that machine that can dig as deep as you want. You drive this digging machine as far as it can go. What do you find?

3. Do a new drawing of yourself and the digging machine and the hole. Your drawing must show the hole that the machine makes if you let it go on until it cannot go further.

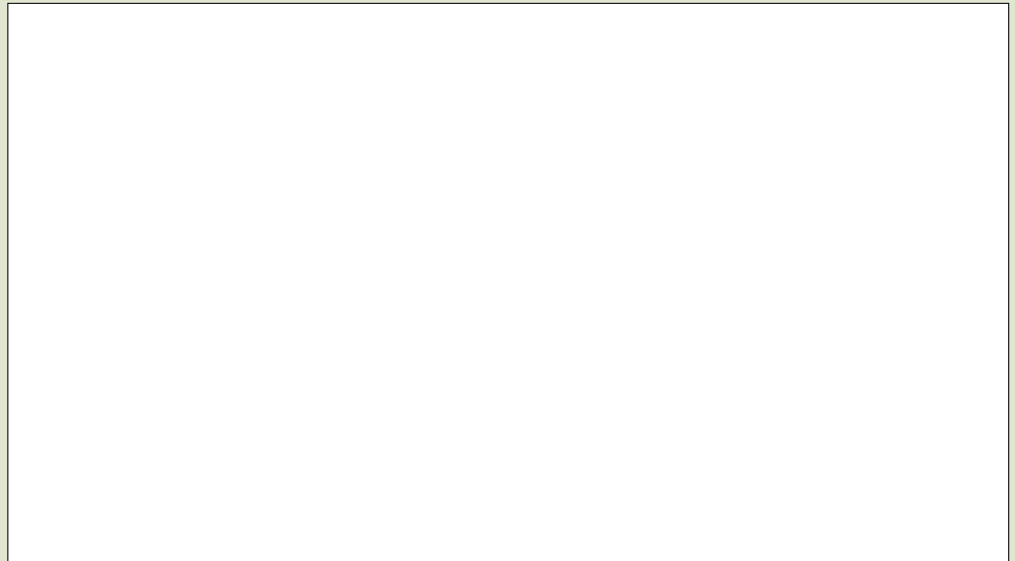

4. Do you think the same as you did, when you began this chapter? Have you changed your ideas about the Earth?

5. Use the classroom globe to answer this question: If you dug a hole straight down into the Earth from South Africa, and went through the core of the Earth, where would the hole come out? Draw a picture in the space below.

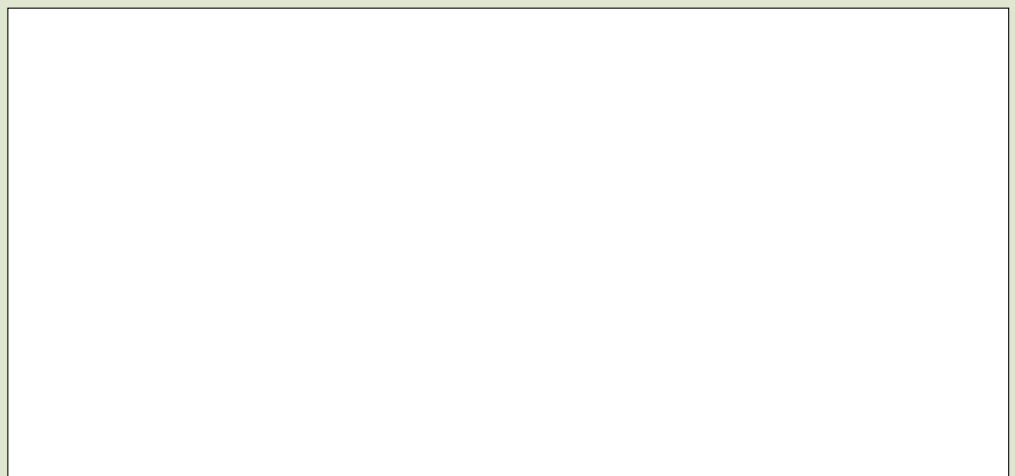

2.2 Soil comes from rocks

Rocks do not last for ever! They may seem very hard and indestructible, but let's have a look!

ACTIVITY: Can hard things like rock and stone wear away?

Stones are hard. People say that a thing that is made of stone will last for ever. But is this true?

MATERIALS:

- two stones (pieces of rocks)
- a sheet of paper.

INSTRUCTIONS

1. Find a cement step that everyone at the school walks on. Sweep the step clean and then look carefully at the step.

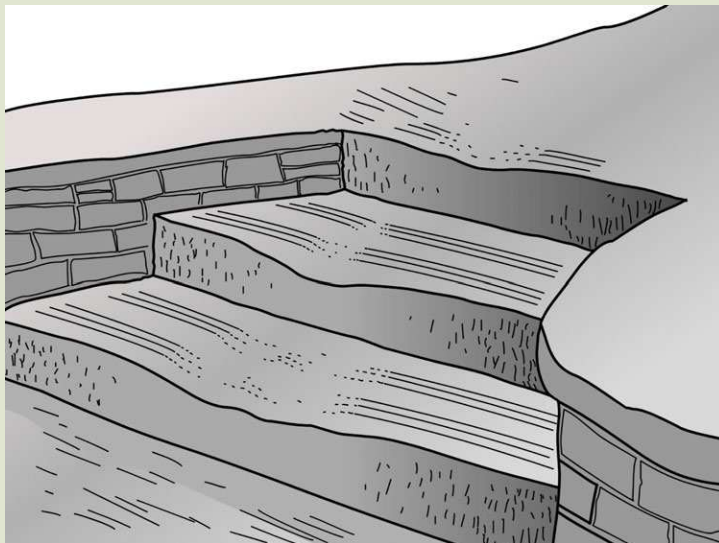

Why are these step wearing away?



NEW WORDS

- expand
- contract
- weathering
- surface
- microorganism



2. Can you see where people put their feet? What has happened there?

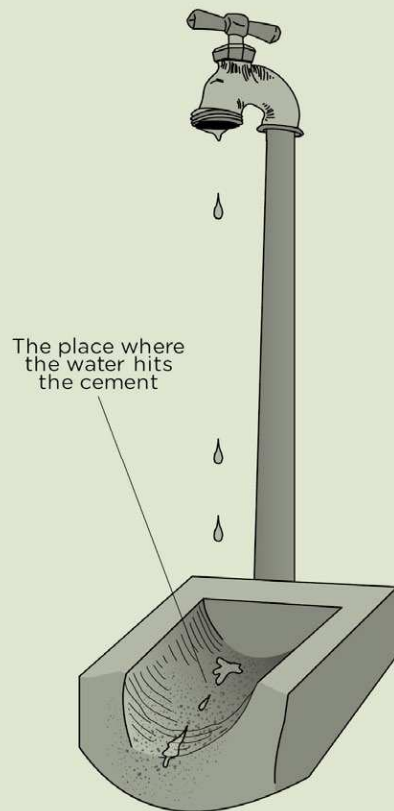

3. Find a piece of cement under an outside tap. Look carefully at the cement, where the water falls on it. You might see that the cement is rougher just where the water hits it. The cement has lost little pieces.

Look at the place where the water hits the cement. How is the cement changing?

4. Find out how long the cement has been there. Perhaps it was put in when the school was built. So how many years did it take to wear away the cement?

5. Find another object that is being worn away. Tomorrow, tell the class what you have found and write what it is below.

6. What do you think is wearing away the object?

7. When a small bit breaks off the object, where do you think it goes?

8. Are the small bits still lying somewhere, do you think?

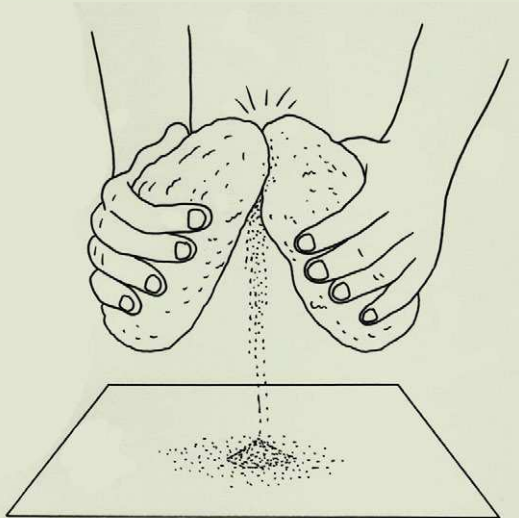

Rubbing rocks together to make sand.

9. Now rub the two rocks together for three minutes. Let all the little pieces fall onto the paper.

In nature, rocks turn into sand. But how does it happen?

Big rocks break up into smaller rocks

We know that we can break big stones into small stones. But when we see small stones lying on the ground, it is hard to think how they were broken up.

In nature, rocks break up in many ways. We will look at just three of those ways.

1. Bigger rocks break up into smaller rocks

Over time, rocks can get cracks in the surface. Water gets into the cracks and causes the cracks to get bigger. Pieces of rock then break off when the cracks get bigger. Smaller and smaller pieces of rock form as the rocks break up more and more.

DID YOU KNOW?

The volcanic rock known as pumice is the only rock that can float in water.



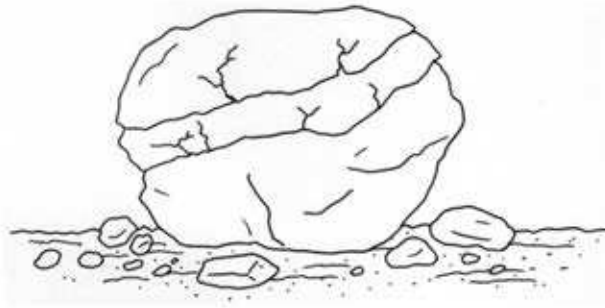

Can you see the cracks forming in this rock to make smaller and smaller pieces of rock?

VISIT

Rocks erode to form soil (video).

goo.gl/6Rd6D



2. Water breaks up the surface of rocks

In the soil, we can find a little water. The roots of plants can change this water so that the water becomes an acid. Vinegar has acid in it, and that is why vinegar tastes so sour.

Acid can work on stones to break them up. The acid water breaks the surface of the stone and then the stone can break more easily.

Rain water can also break up and wear down the surface of stones causing small pieces to break off. We saw an example of this with the water from the tap breaking up the cement.



Rain wears down rocks and causes smaller pieces to break off.

3. Stones rub together, and their surfaces break up

Stones rub together when water moves them, or when wind blows them against bigger stones. People and animals walking on a path kick stones and break off little pieces. Small stones become even smaller, and the small pieces become sand.

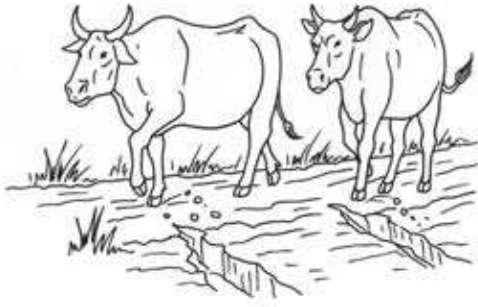

People and animals break stones into smaller stones when they walk over them.



The constant impact from heavy tractors driving through will break larger rocks up into smaller pieces.

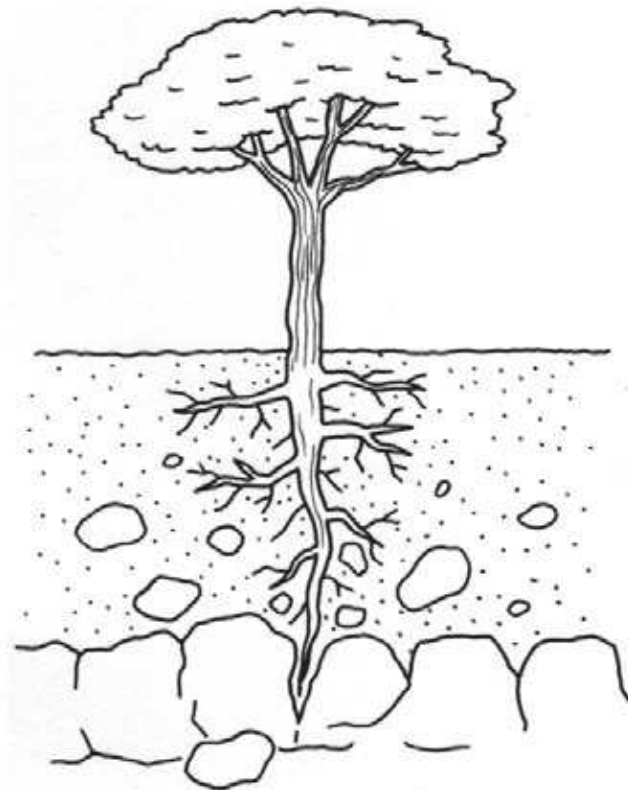

The roots of plants also cause stones in the soil to rub together and break up into smaller pieces.



ACTIVITY: Make a model of acid water breaking up rocks

In real soil this change takes many years. We can make it happen in the classroom in a week. Look at the picture below.

MATERIALS:

- a cement brick (not the shiny dark red or orange bricks)
- a large plastic container (like the bottom half of a plastic cool drink bottle)
- a bottle of white vinegar.

Jar cut from 2-litre cold-drink bottle

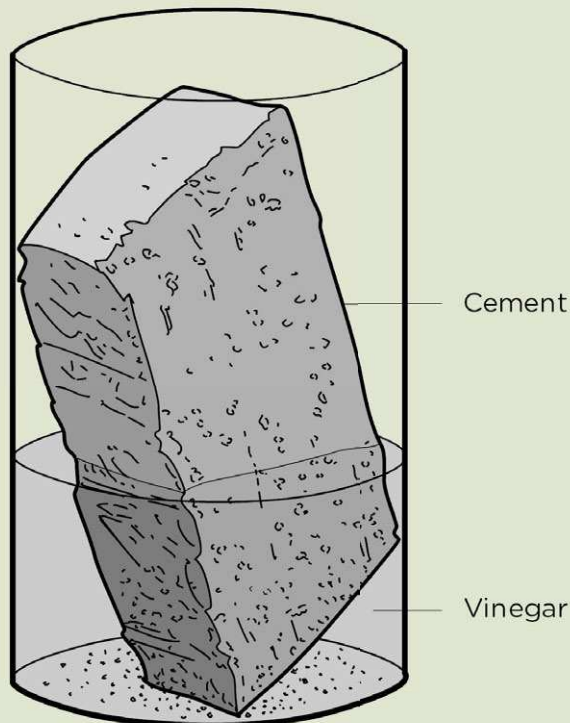

*Vinegar acid is working on the surface of the cement brick.
Parts of the brick are falling off.*

INSTRUCTIONS:

1. Put the cement brick into the container.
2. Pour enough of the vinegar into the plastic container to cover half of the brick.

3. Put the container in a place where everyone can see it every day for two weeks.
4. Cover the container and make sure the mixture does not evaporate and leave the brick dry.

QUESTIONS:

1. Draw the brick as it looks on Day 1.

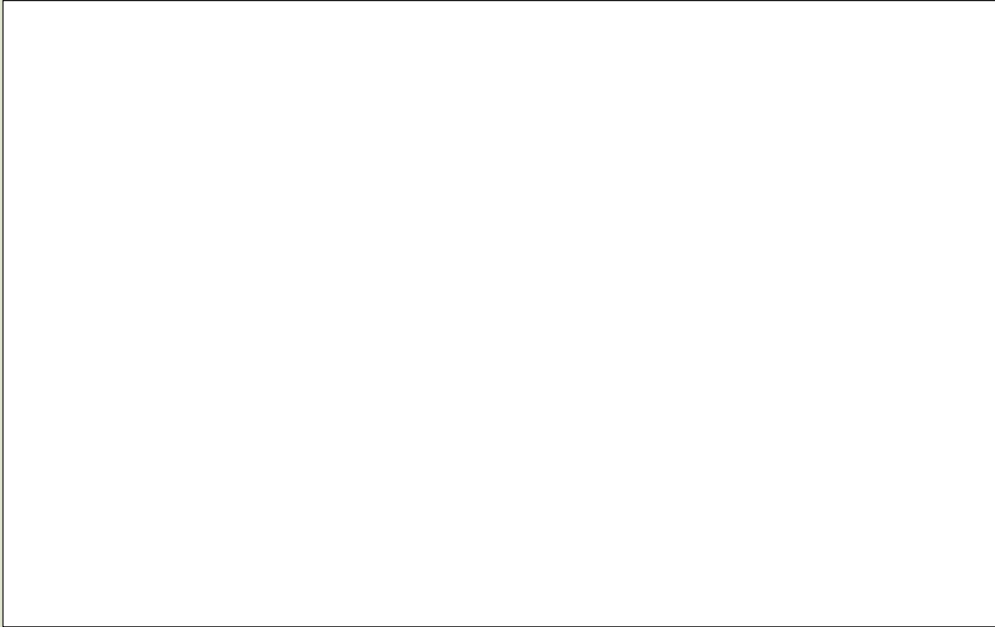

2. Draw the brick as it looks on Day 14.

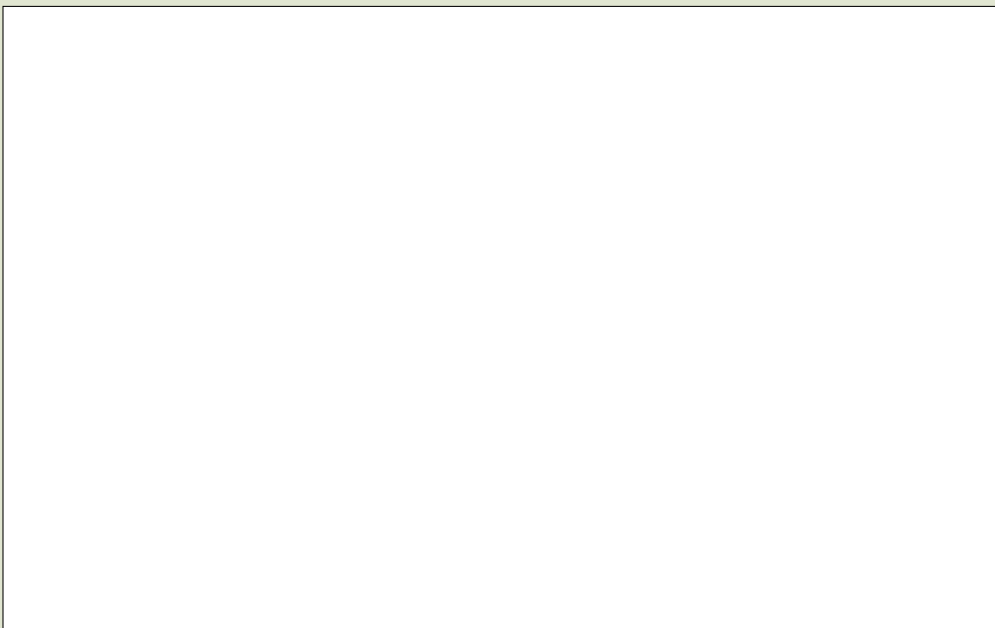

3. What changes have happened to the brick?

4. Has the part of the brick that is above the vinegar changed in the same way as the part that is under the vinegar?

5. Have any parts of the brick fallen off to the bottom of the container?

6. Write out the whole sentence in your book and complete it with words from the word-box:

This equipment is a model of rock, not the real rock. The brick _____ a real rock and the vinegar _____ water around the roots of plants.

Word box: Use some of these words

- represents
- represents the real
- is not

Making soil

Rocks break down and slowly change into sand. This change needs thousands of years to take place because soil, wind and water do it very slowly. But sand is not soil. More changes must happen to sand before it is soil.

ACTIVITY: Look at different kinds of soil

MATERIALS:

- a tin-can half full of moist topsoil (moist means it is not dry)
- a hand lens or some other kind of magnifier
- a sheet of white paper
- toothpicks, matches or pieces of dried grass that you use for moving the little pieces of soil.



INSTRUCTIONS

1. Smell the soil in the tin. Does it have a smell?
2. Put a teaspoonful of the topsoil on the white paper and spread it out.
3. Use your stick to move the small bits of soil that you find there. Look at the soil with the magnifier. Make piles of bits that look the same.

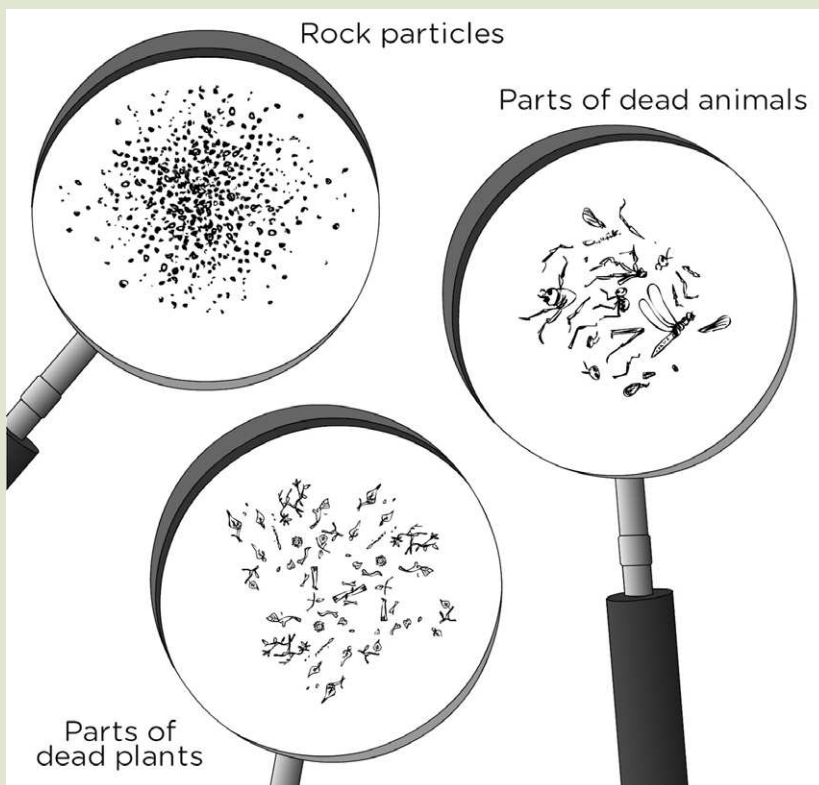

Look closely at the soil. What pieces do you find there?

- One pile will be rock grains. You will find very small pieces of rock and some pieces that are not so small. There will also be some grains that are almost too small to see.
- Another pile will be small bits of plants. You will find very small pieces of sticks, leaves and roots.
- Another pile will be small bits of animals. You will find very small pieces of beetle shell, or legs, or wings of flies.
- You may even find a small live animal! If you do find one, do a drawing of it on your paper and then let it go on the soil outside.

QUESTIONS:

1. What colour is your soil? Use words like "dark brown", "grey" "orange" or "yellow".

2. Complete the sentence: Soil has sand but it also has....

3. Draw some of the grains of rock (sand) that you find. Draw any small bits of plants or bits of dead animals that you see in the soil. Draw any small living animals that you find in the soil. Then let them go, outside.

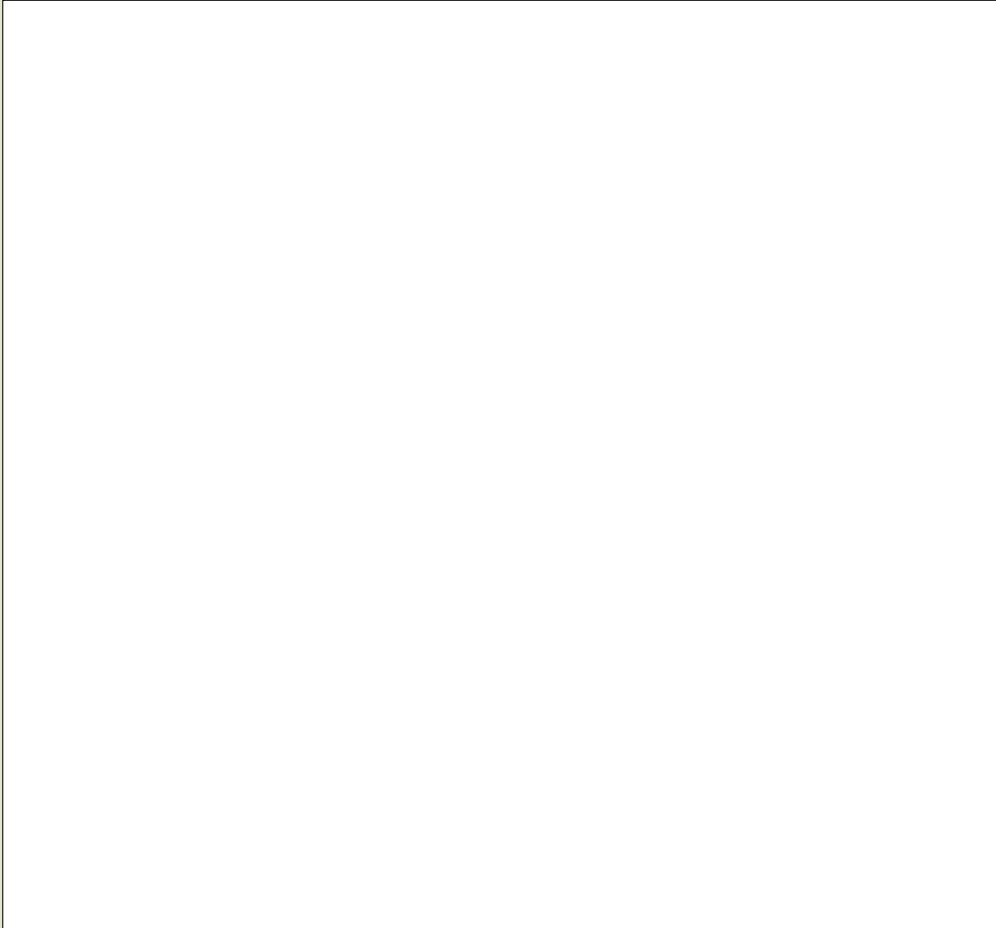

We can make soil in a few weeks, but only a small amount of soil.

ACTIVITY: Begin to make soil

In this activity you begin the slow process of making soil. Your class perhaps started your compost column in the first week of the term.

MATERIALS:

- 3 big cool drink bottles like the ones in the picture
- an old stocking
- a strong rubber band
- felt-tip pens that will write on plastic



- a big needle
- a pair of scissors
- scraps of vegetables and fruit, leftover porridge, cut grass, enough to fill a big bottle to the top
- a cup of water

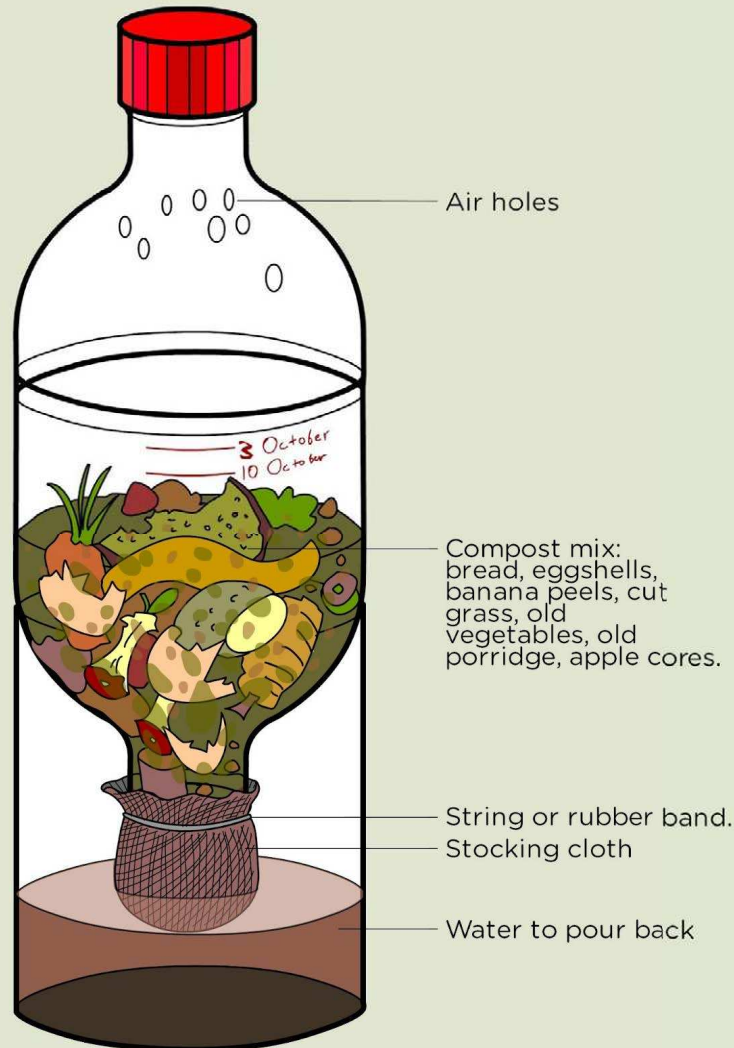

Cut and join 2 cooldrink botteles like this.

INSTRUCTIONS:

1. You need the plastic bottles that you see in the picture. Cut them as you see and join them together as in the picture.
2. Cut a piece of stocking to fit over the neck of the bottle that is upside down. The stocking will stop the vegetable peels falling through the hole, but it will let water go through.
3. Add the vegetable peels, old bread, and leaves.

4. Now slowly pour in the cup of water. Let the water go down through the stocking, into the bottom container.
5. Now use the needle to make air holes in the top bottle, as you see in the picture.
6. Mark the height of the compost column on the plastic. Write the date next to the mark.
7. Each Friday, mark the height of the compost column again, and write the date on the bottle.
8. Then, take out the bottom container with the water in it, and pour the water into a tin.
9. Then, use the tin to pour all the water slowly back into the compost. This will stop the compost from drying out.
10. Begin a class logbook. A logbook is a book in which you write down what happens on a day. Look at the example below which shows Sophie's log book from when the Thunderbolt Kids did the experiment in their class.

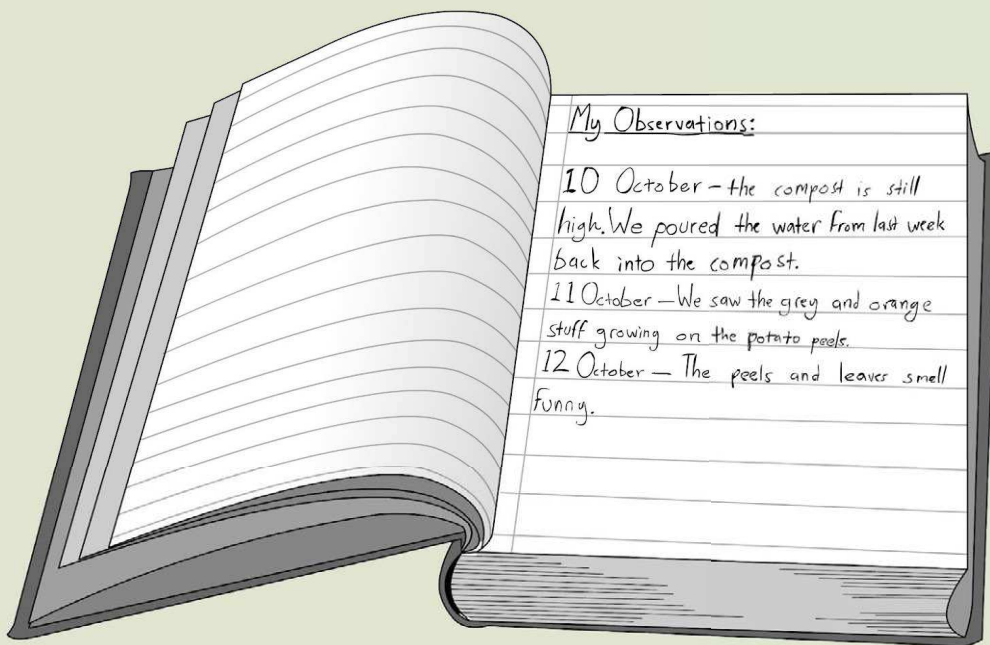

This is what you may see in Sophie's logbook.

In the beginning, you might think the compost looks ugly, and is just a lot of rotting food and leaves. It might have a smell. But as the weeks go by, you will see changes in the colour and the size of the small pieces. You will also see some things begin to grow in the compost. The smell will change. You may also see insects appear from the compost.

QUESTIONS:

1. Did you notice any changes in the compost? Did you see anything begin to grow in the compost?

2. What happens to the colour of the water that you pour back in every week?

3. What do you think is in the water?

4. Why must you use the same water each week and not take fresh water?

5. Why does the compost column become lower as the days go by?

6. Where do you think the insects come from?

The grey hairy things that you see growing in the vegetable peels are fungi, and they help to break down the peels. There are many kinds of fungi and they have different colours.

When you see insects in the compost column, they may be fruit flies that can get in through the air holes, but they may also be hatching from eggs that insects laid in the peels and leaves before you put them into the plastic bottles. Do you remember in the first term when we did Life and living, we observed the life cycle of fruit flies?

After about 4 weeks, your compost will be a dark colour and the big pieces will have broken down into small pieces. You can pour out the compost and mix an equal amount of sand with the compost. Now you have made a little soil.

Microorganisms in the soil

When you looked at soil, you found sand grains, small bits of plants and small bits of animals. But there was another group of things you could not see, because they are too small. They are microorganisms. They are alive and they are busy in soil, changing dead plant and animal material into substances that plants can use and absorb through their roots.

If we work hard, we can make a small amount of good topsoil in a term. But a farmer needs good topsoil all over the farm. Nature works all over the Earth but it works very slowly. Nature needs about 1 000 years to make topsoil just 10 cm deep. If rain washes away the topsoil, the farmer cannot grow good crops on that land. Look at the picture below.



The topsoil has gone from this land, and the farmer can never grow food here again.

Even if the farmer stops the erosion, it will be about 1 000 years before nature can make new topsoil to replace the soil that has gone.

If there is too little top-soil, then there will be too few plants for animals to eat. So all animals depend on the top-soil, even animals like lions that only eat meat.



QUESTIONS

We can say that lions depend on top-soil for their food, although they do not eat top-soil. Why do lions depend on the top-soil for their food? Explain your answer. Hint: Think back to what you learned in the first term in Life and Living about food chains.

2.3 Soil types

Have you ever noticed how many different colours of soil and textures of soil there are? Even if you are just walking around your school ground, you may come across many different types of soil.

This is because there are different particles which make up soil. These particles can vary in amounts and therefore make up different types of soils.

Some particles are bigger, others are smaller and some are in between. A soil sample normally has a lot of particles either bigger, smaller or in between and a smaller portion of the other sizes.

Soil particles - Sand, silt and clay

There are 3 main types of particles which make up soil:

1. Clay
2. Silt
3. Sand

NEW WORDS

- clay
- loam
- humus
- sample
- silt
- compare



If the soil was formed from a very hard rock, then it has bigger particles, if it was formed from a soft rock then the particles will be smaller.

INVESTIGATION: Different amounts of sand, silt and clay

AIM:

To find out how much sand, silt and clay there is in soil from two different places.

PREDICTION (what you think you will find out):

The soil from _____ will have more _____, and the soil from _____ will have more _____.

MATERIALS AND APPARATUS:

- soil from two different places, such as near the top of a slope/hill and near the bottom. Or take soil from under a tree and other soil in an area with wild grass. The soils should look different.
- sheets of newspaper to keep the desks clean
- two large see-through jars **the same size.**

INSTRUCTIONS:

1. Collect two tins of soil from places you choose. These are samples of each kind of soil (a sample is a little bit to study).
2. Feel the two samples in your hand. How do they feel different? Do they smell different?
3. Spread a teaspoonful on the white paper and look at each - in what ways do they look different?
4. Then put your soil samples into the glass jars. Pour in water to make the jar almost full, cover the top and shake each jar to mix the soil and water.



5. Now leave the two jars to stand until tomorrow. The water must not move.
6. In the morning you will see something like in the picture below. In each jar, the water has let the large grains settle at the bottom, the very small grains are on top, and the clay grains are so small they are still mixed with the water. You may see some plant parts floating on the water.
7. Your two jars will show different layers. In one jar, you might see a lot of sand, and in the other jar you might see less sand.

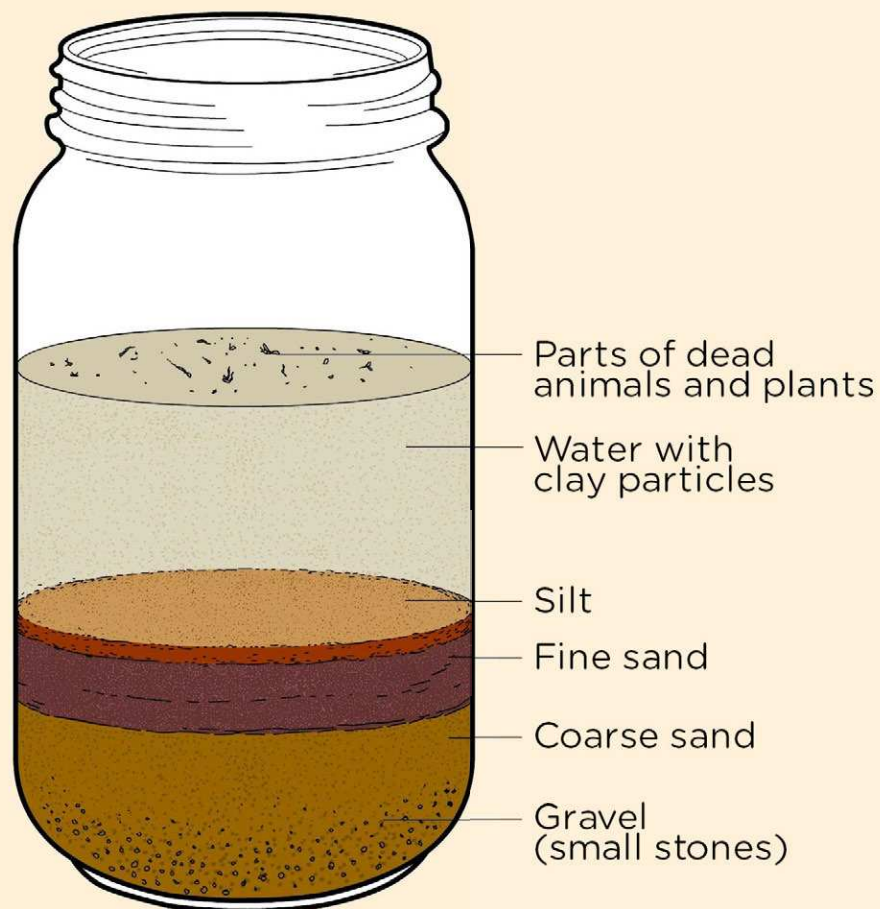

You will have two jars like this. The parts of your soil settle in layers.

OBSERVATIONS:

Draw the two jars showing the layers in your two sand samples. Give your drawings labels and a heading.



How could you do this investigation better?

CONCLUSION (what you learnt):

The difference between our two soil samples is that...

You will see that your soil has some grains that are grains of sand, some grains that are smaller and some that are so small you can't see them.

- **Sand**, which you know how it feels between your fingers.
- **Silt** has much smaller grains but you can still feel that the silt is a bit rough.
- **Clay** has such small grains that when you rub it between your fingers it feels like paint. In fact you can paint with it. When clay dries, it becomes hard.



QUESTIONS

1. Can you make pots with sand?

2. What kind of soil is good for making pots?

Soil types - Sand, clay and loam

As we saw previously, different soil samples collected from different places have different size particles. Imagine running along the beach and feeling the sand beneath your feet. Now imagine running through a forest over the soil. Can you see there are big differences in these types of soil?

The mixture of particles and the size of particles determines the soil type. There are 3 different types of soils:

1. Clay
2. Loam
3. Sand

Let's look at the characteristics of the soil types.

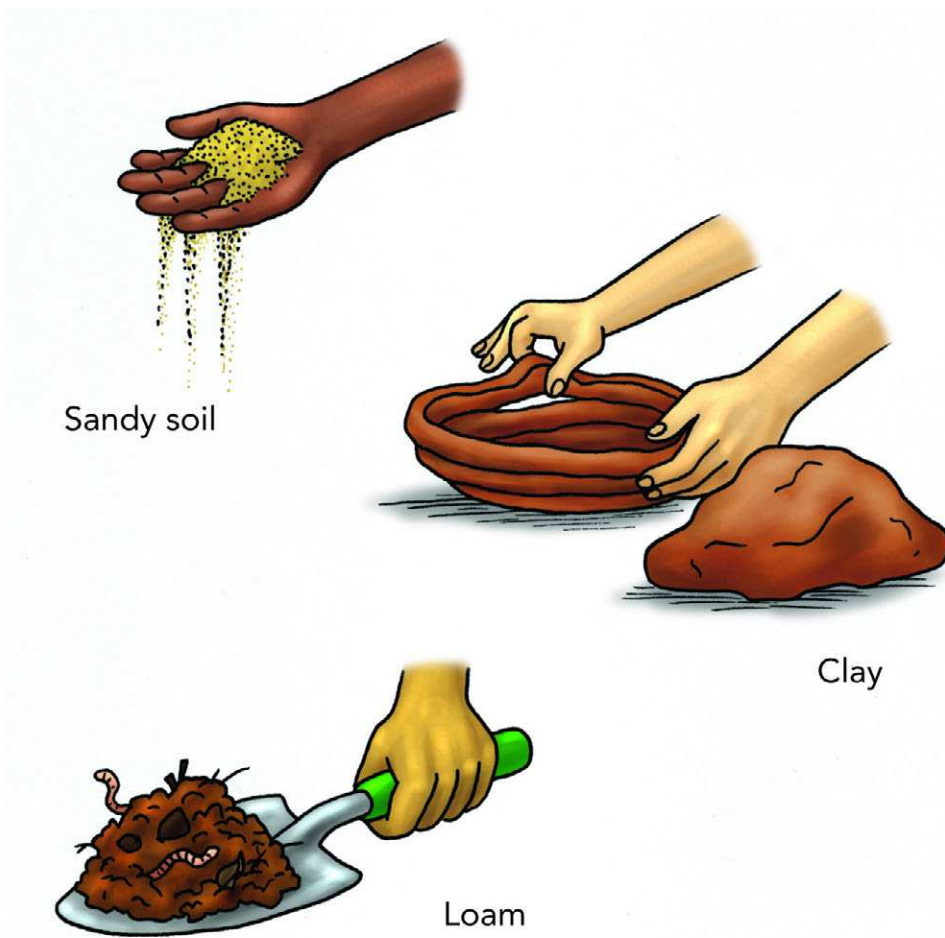

The types of soil.

Sandy soil is the soil you find at the beach. It consists of large gritty particles and very tiny bits of rock which we call grains of sand. The grains of sand are coarse and the soil is loose.

Can you see how in the picture of sandy soil, the grains can fall through your hand? It does not retain fertilisers. It is easily washed or blown away. It becomes warm quickly on a sunny day. Plants do not grow well in sandy soil.



Sandy soil has lots of coarse grains of sand.



QUESTIONS

1. Why do you think plants do not grow well in sandy soil?

Have you ever made a pot out of **clay**? If you are lucky enough to have done this or seen someone do it, you will know a bit about the properties of clay.

Clay can be moulded. This is because it consists mainly of very fine particles which cling together. Clay gets sticky when wet. It retains fertilisers for a very long time. It is difficult for clay to be blown away or washed away. It does not become as warm as sandy soil.



Clay soil consists of lots of very fine grains of clay and can be moulded into pots.



QUESTIONS

2. Do you think plants will be able to grow in clay?

Loam is a very funny word! But this is also a type of soil. Loam is actually a mixture of clay, sand and humus. Humus is organic material from plants and animals which is decomposing.

Loam is fairly loose and fertile. It retains fertilisers longer than sandy soil. It is not easily blown or washed away. It is much cooler than either sand or clayey soil. Loam soil is the best type of soil for plants to grow in!



Loam soil is rich with humus.

VISIT

Interesting website
about soil types.
goo.gl/QMnsG



QUESTIONS

What are the differences between loam and sand soil? Name three things that you find in loam but you do not find in sand.



Each soil type also has air and water in it, and sometimes the remains of dead organisms and very small living organisms.

How do some plants live when no rain falls?

We do know that many plants can live through the dry season, even though no rain falls for eight months. How do they do it?



ACTIVITY: Soil holds water

MATERIALS:

- a spade
- a large sheet of clear plastic
- a few bricks

INSTRUCTIONS:

1. Look at the picture below.
2. Dig a hole in the soil outside, like this.
3. Cover the hole with a sheet of clear plastic and hold it down with some bricks.
4. After a short time, you see drops of water on the plastic.

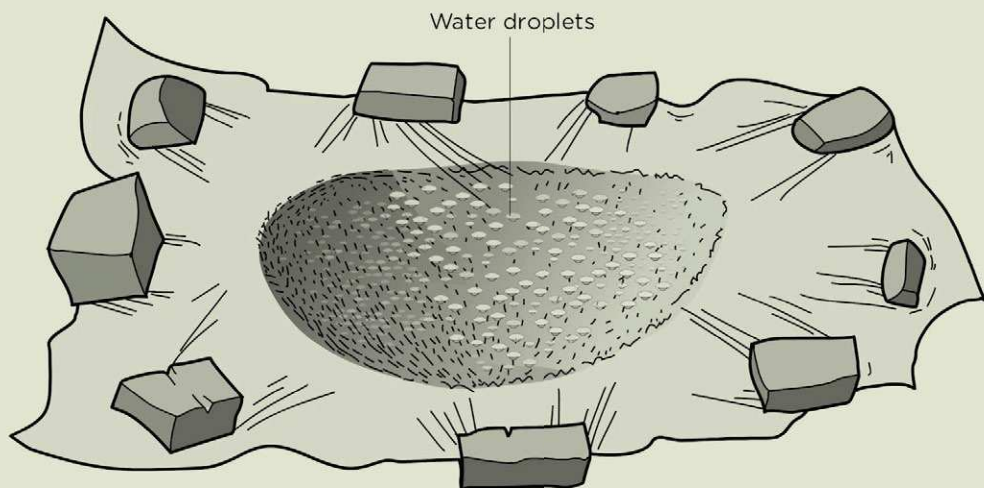

Dig a hole in the soil, and cover it with a clear plastic sheet.

QUESTIONS:

1. Are the drops on the top or the bottom of the plastic?
-

2. Where is the water coming from?

3. How did the water get into the soil?

4. Some plants can live even when no rain falls. How do they live?

Farmers know that soils are not all the same. They know that some soils hold water well, and other soils do not hold water well.

An easy way to see how well soil holds water is to pour some water into soil and let it run through into a bottle. Look at the first picture below. These two bottles are the same size. In the next picture, the water is poured into the jar with the soil in it. Look at the last picture - has all the water run through the soil?

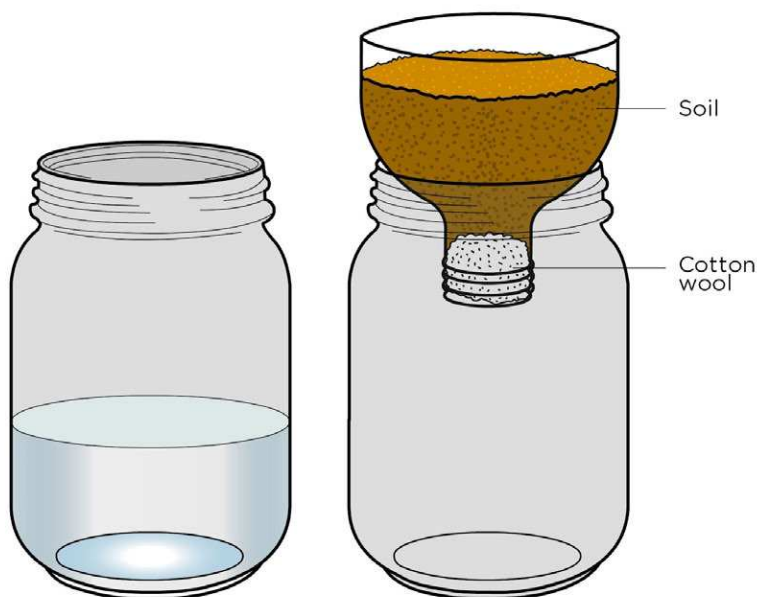

Put the soil in a funnel, like this. Use two jars the same size.

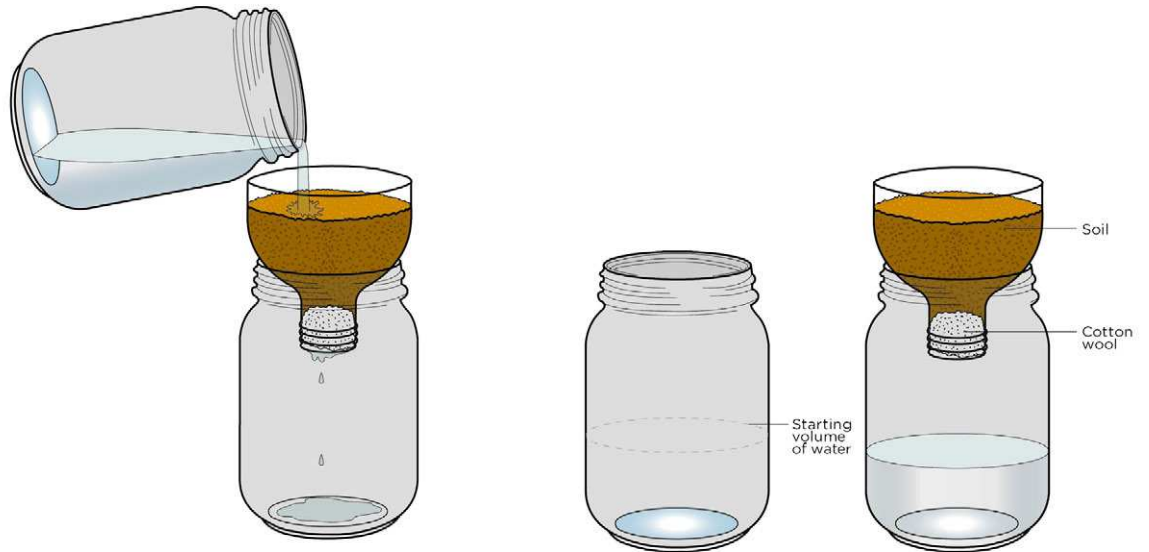

Slowly pour the water onto the soil, and wait 5 minutes.

Has all the water run through the soil?

Let's do an investigation to see how much water the different soil types can hold. For this investigation activity you need two different kinds of soil, from two different places. Let us call them Soil A and Soil B.

Plan an investigation to compare Soil A, Soil B and Soil C, and then do the investigation. The main question you must answer is the question, **which soil holds more water?**



INVESTIGATION: Which soil holds more water, Soil A or Soil B?

When you compare things, you must be fair. For example, if we want to compare runners in Grade 5 athletics, we must let them run on the same track. It is not fair if we let some of them run through bushes but the others can run on a smooth track! We must treat all the runners in the same way, to be fair when we compare them.

Set up the soils as you see in the picture below; in funnel A, the soil will hold some of the water you pour in. In funnel B, the other soil will also hold some of the water you pour in. But will they hold the same amounts?

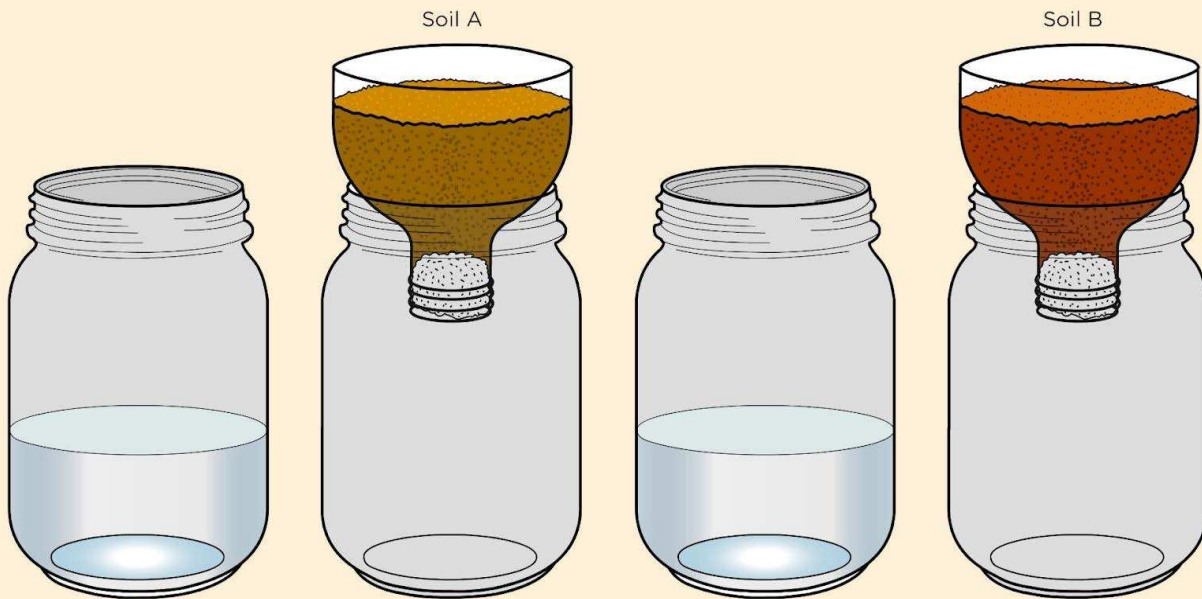

Setup the soils in two funnels like this.

What will you do to make sure you are being fair?

AIM (What you want to find out):

PREDICTION/HYPOTHESIS (What you think will happen):

MATERIALS AND APPARATUS (what you will need):

Look at the pictures above to help you write a list in the space below.

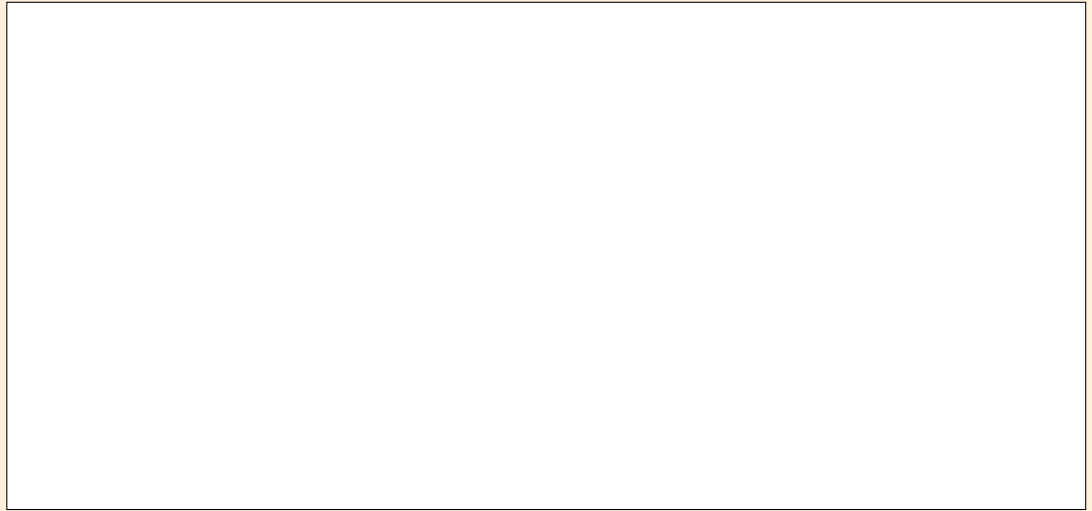

METHOD (What you must do):

Write out the instructions for how to carry out this investigation below. Remember to number the steps.

RESULTS AND OBSERVATIONS:

What did you observe when doing this experiment?

Use the space below to draw a bar graph to show your results from this experiment. Remember to label the axes of your graph and give it a heading.



How could you do this investigation better?

CONCLUSION (What you learnt):

Write a sentence where you give a conclusion about what you learnt from this investigation. See if you can identify what types of soil A and B were.

Sandy soil does not hold much water. Clay soil holds too much water. Clay holds water because it has very small grains. The grains fit together tightly. Loam soil has a mixture of sand and clay, along with composted plant and animal substances. So, loam soil holds water well, but does not become waterlogged like clay soil.



QUESTIONS

Why does sand let the water run through quickly?

Which soil type do plants grow best in?

Now that we have looked at how different soil types hold different amounts of water, let's compare how well plants grow in the different soil types. In Life and Living, you might have grown seedlings before, but let's try again and this time focus on the type of soil.



INVESTIGATION: Compare how well plants grow in different kinds of soil

AIM (What you want to find out):

PREDICTION/HYPOTHESIS (What you think will happen):

MATERIALS AND APPARATUS:

- 3 large jam tins
- packet of radish seeds
- some sand, enough to fill one tin
- some loam soil, enough to fill a tin. You can find loam soil in a vegetable garden
- some clay soil, enough to fill the last tin (if you have access to clay soil)
- a ruler
- a measuring cup
- a table spoon

METHOD:

1. Make five small holes in the bottom of each tin, so that water can drain out if there is too much water in the tin.
2. Fill one tin with sand, one tin with the loam soil, and the last tin with clay soil.
3. Plant 10 radish seeds in each tin. Cover the seeds by sprinkling a little of the sand or soil over them.
4. Pour a cup of water into each tin. Remember to keep the amount of water constant to make it a fair test.
5. Now let the seeds begin to grow, perhaps on the windowsill in the classroom to make sure that they have a light source.
6. Each day, give each tin a tablespoon of water.
7. Observe the radish seeds growing for a week, and compare them.
8. Measure the height of the radish plants growing in each type of soil. Calculate the average seedling height for each soil type.
9. Record your results in a table.

RESULTS AND OBSERVATIONS:

Use the space below to draw a table to record your results from measuring the height of the seedlings each day. Give your table a heading.



Average height grown by seedlings in different soil types.

Date	Loam soil (mm)	Sandy soil (mm)	Clay soil (mm)

Now draw graphs to compare your results. A table is one way of presenting results, but a graph gives a visual representation which is sometimes easier to quickly understand and compare the results from an experiment.

First draw a line graph to show the change in average height of the seedlings grown in loam soil over time.



Next, draw a bar graph to compare the average height of the seedlings on the last day of your investigation for each soil type used.

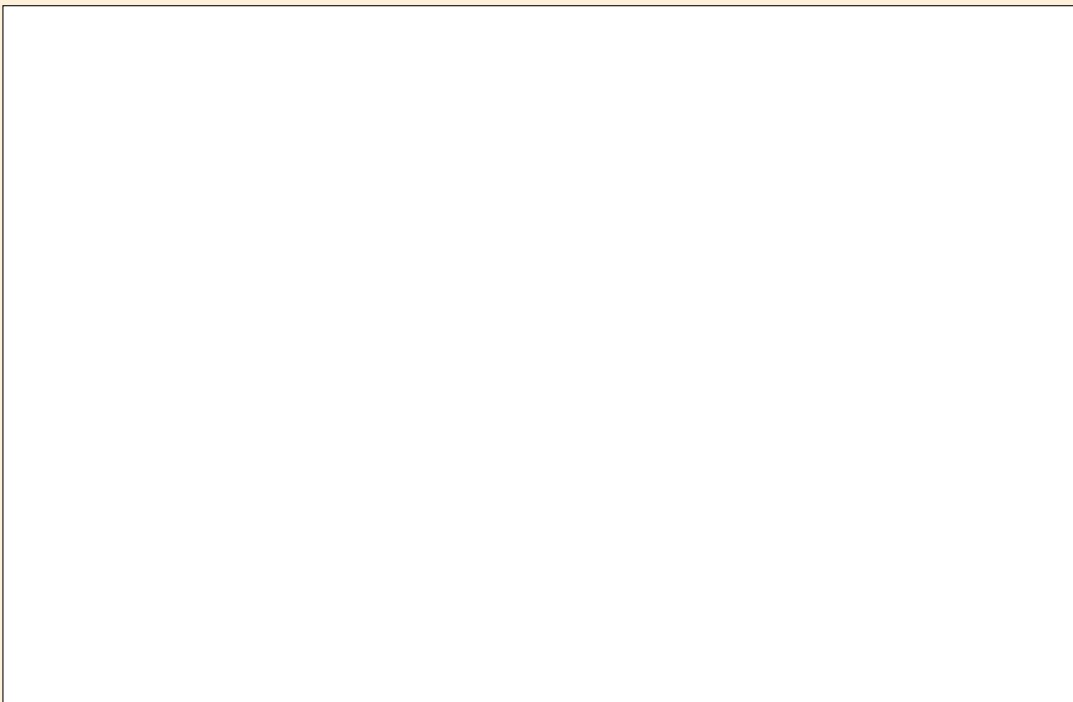

How could you do this investigation better?

CONCLUSION:

Write a conclusion for this investigation. Remember, in a conclusion you must answer the question which you set out to investigate at the start.



KEY CONCEPTS

- The rocks on the surface of the Earth form a crust that covers the whole planet.
- The continents are part of the crust, and the bottom of the oceans are part of the crust too.
- Rocks break up into small grains.
- The remains of living things mix with the grains and together they form soil.
- Three types of soil are sandy soil, clay soil and loam soil.

REVISION:

1. Label the layers of Earth on the following diagram:

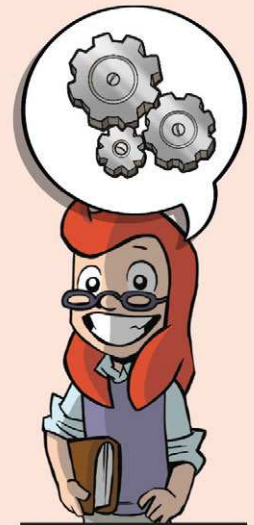
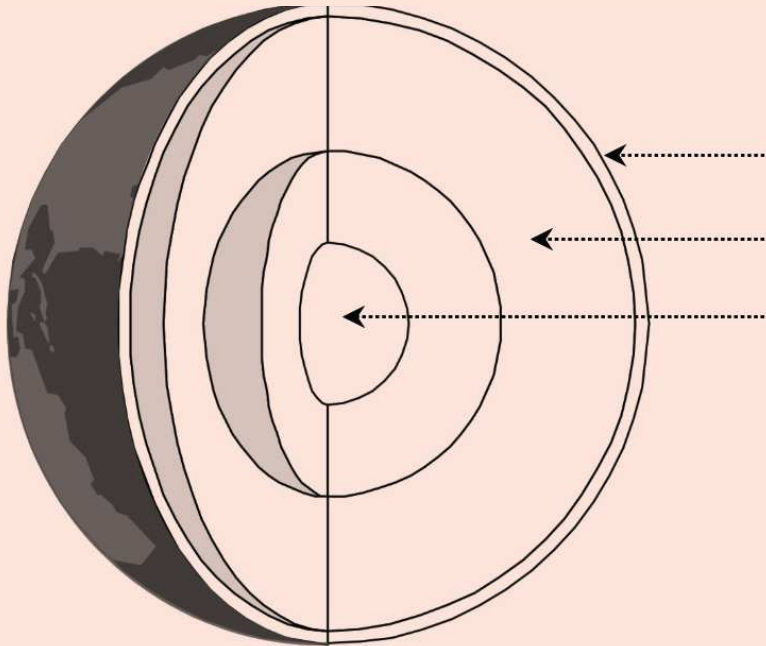

2. What is the crust of Earth made of?

Use some words from the word-box to complete the sentences in questions 3 to 6. Write out the whole sentence each time:

sand, clay, silt, photosynthesis, animals, topsoil, subsoil, food, loam

3. The weathered rock becomes part of the soil. The big and small grains of rock mix with parts of dead plants and _____. This mixture is called topsoil. _____ can hold water that plants need.

4. Loam soil is topsoil. It has a good mixture of _____ soil. _____ holds enough water for most plants, not too much and not too little.

5. Plants need the nutrients in topsoil to make food by the process of _____. Plants are food for most animals. Some of these animals are food for meat-eating animals. So without _____ there will be no plants and no animals.

6. We have to stop top-soil washing away when it rains because we need _____ to grow _____ .

7. What is humus and where would you find it?

-
8. Look at the picture below of two different plants growing. Why do you think the one plant is healthier than the other plant? Explain your answer.

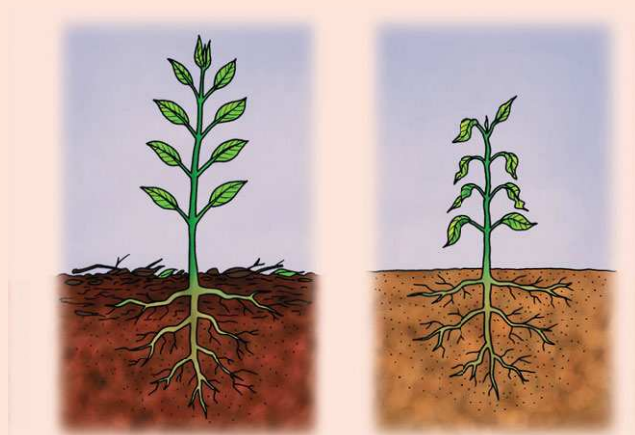



KEY QUESTIONS

- Why does the Earth have mountains and valleys?
- Have mountains always looked like they look now?
- Why can you sometimes see "layers" in rock which are different colours? How did these layers form?

We saw in Chapter 2 that the surface of the Earth is made up of rocks and soil. There are different soil types, but did you know that there are also different types of rock? We classify rocks depending on how they were formed.

We are only going to look at Sedimentary rock in this chapter and find out how it is formed and used.

VISIT

Different rock types
(video)
goo.gl/yD3qd



3.1 Formation of sedimentary rock

In Chapter 2, we saw how rocks break up into smaller and smaller pieces, until we have grains of sand. Now we find out what happens to the sand.

First, rocks break up into smaller pieces, until the pieces are grains of sand. Next, wind and moving water carry the sand and mud away. Then, the wind or the water may drop the sand and mud in one place. Finally, the sand grains might get stuck together again over time and make new rock. This new rock is called sedimentary rock.

Erosion and deposition

When wind or water move the pieces away from the rock, we call this erosion. The wind and water erode the rock as they carry away the sand.

NEW WORDS

- weathering
- grains
- sediment
- sedimentary
- erosion
- deposition





A large valley is forming due to soil erosion.



Soil erosion due to water.

When the wind and water put the sand grains down, we call this **deposition**. The wind and water **deposit** the sand.

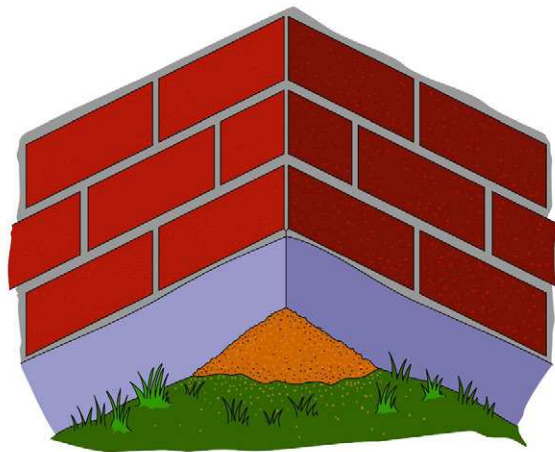

*The wind is depositing sand in this corner of the school.
Deposition is happening here.*

Sediments

When the sand grains collect on top of each other, they form a sediment. Over time, new layers of mud and sand are deposited on the previous layers. Over a very long time, these sediments become compacted and hardened and become sedimentary rock. This happens because the grains of sand become glued together, and other heavy sediments press down on the grains of sand. Sediments lie on top of each other. We can actually see these layers in sedimentary rock and they are sometimes different colours. Find the sediments in the pictures below.

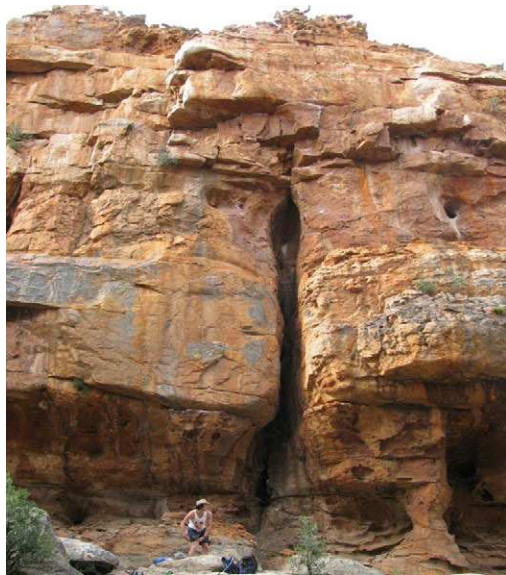

Sandstone rock in the Cederberg in the Western Cape.

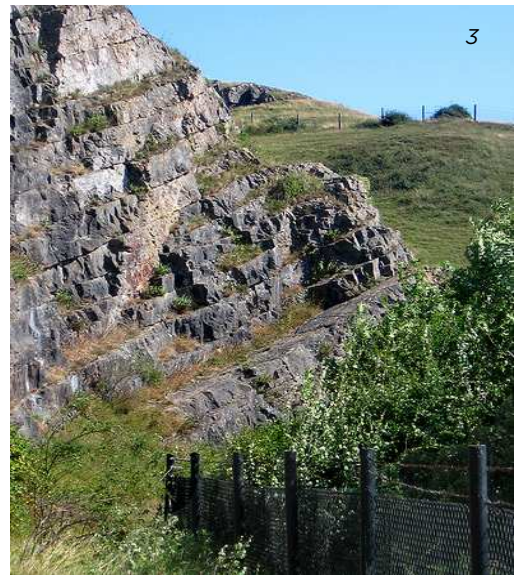

Layers of limestone sedimentary rock.



Can you see the different coloured layers in this sedimentary rock?



Look at these layers in this sedimentary rock known as shale.

Let's have a look at how sediments are deposited over time. Except, we do not have thousands of years so we are going to pretend each day of the week is actually about 1000 years!



ACTIVITY: Depositing sediments

MATERIALS:

- A large see-through jar. You can make this from a 2-litre cold-drink bottle.
- different places for groups to collect sand and soil.

INSTRUCTIONS:

1. Put the jar in a place where everyone can see it.
2. Group 1 must collect a large jam-tin full of sand and on Monday they pour their sand into the jar.
3. Group 2 must collect sand or soil from a different place. On Tuesday, someone from Group 2 pours that sand into the jar.
4. On Wednesday, group 3 pours in sand or soil from a different place.
5. By Friday, the jar will have different layers.

QUESTIONS:

1. Which sand sediment was put in on Tuesday?

2. Which is the oldest sediment?

ACTIVITY: Which sediment is the oldest?

People who dig holes in the river to get to water sometimes see the sand sediments. The Thunderbolt Kids decided to dig a hole down in the river bed just outside their school. Look at the picture below where you can see Sophie's feet standing on the top and the layers of sediment going down below.



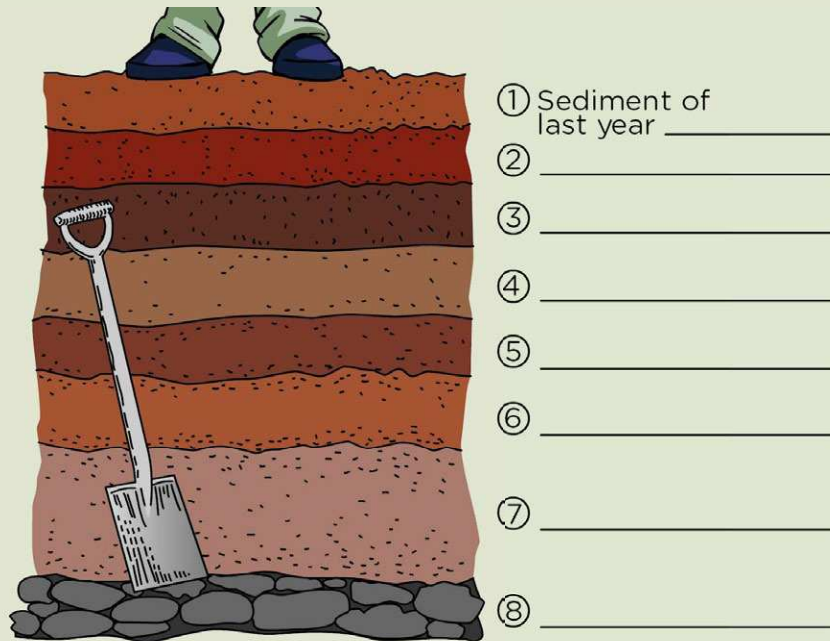

This is what you might see if you dig down in a river-bed.

The river is dry now, but last year the river deposited a sediment. This river deposits a sediment every year when the rains come.

INSTRUCTIONS:

1. Find the sediment of sand that washed down **last** year. Read the number next to it.
2. Find the sediment that washed down **the year before last year**. Read the number next to it.
3. On the picture, complete the label, **Sediment of last year, 2012**.
4. On the picture, where must you write **Sediment of 2011**? Write it there.
5. On the drawing, next to sediment 5, write **I was years old when the river brought this sediment**.
6. In sediment 4, we find the bones of a bird. How could a bird get into this sediment? Write or tell a short story about the bird. Explain why we find its bones under four sediments of sand. Work out in what year the bird fell into the mud.

7. What will you find if you dig deeper than sediment **8**?

Look at the picture below of the Grand Canyon - can you see old sedimentary rock? Look at the sediments of rock. The rock is very hard now. It has been pressed down for millions of years.



Look at the layers in the sedimentary rock in the Grand Canyon.

DID YOU KNOW?
Scientists think the Earth is between 4 and 5 billion years old.



QUESTIONS

1. Show with your finger which sediment of rock is the oldest.
2. Show where you can find soil, in the picture.



Sedimentary rocks are also eroded and broken down into grains of sand again.

DID YOU KNOW?

The oldest layers of sedimentary rock visible in the Grand Canyon are believed to be nearly 2 billion years old.



The sedimentary rock in the Grand Canyon formed a very long time ago. The layers of sediment were once deposited in warm shallow seas and over millions of years they compacted to form rock. The wind and rain have eroded it until it looks like this.

Look at the diagram below which summarizes how sedimentary rock is formed, mostly under the sea or lakes and rivers.

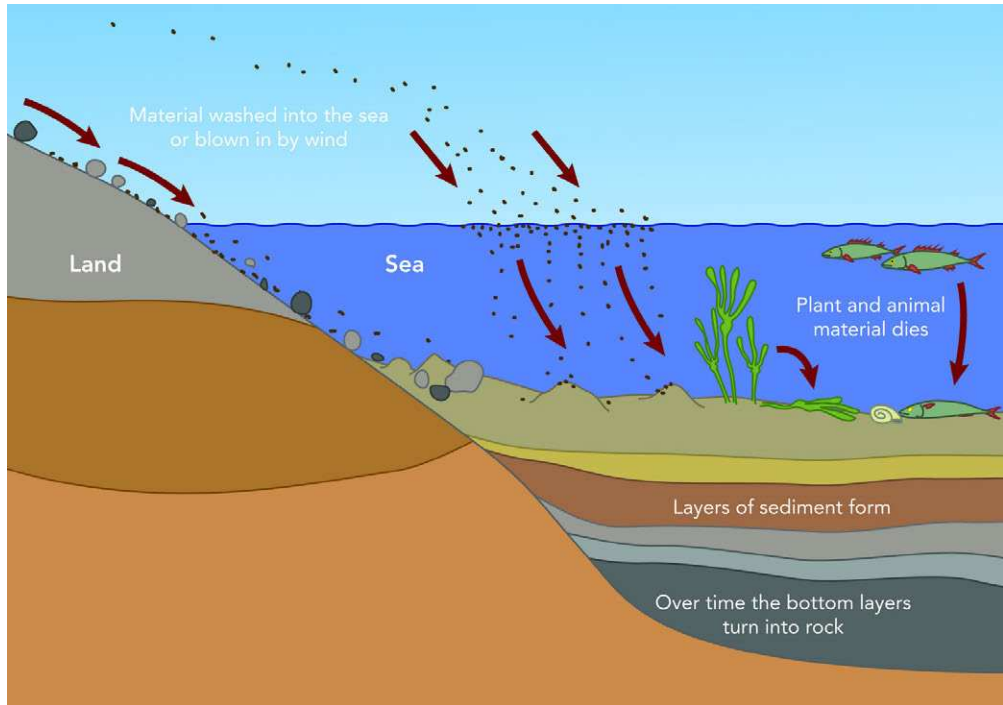

The formation of sedimentary rock.



QUESTIONS

Use the diagram above to write a summary paragraph explaining how sedimentary rock is formed.

ACTIVITY: Rebuild the mountain the way it was

INSTRUCTIONS:

1. Look at the diagram below; it shows mountains that are being eroded.
2. The mountains did not always look like this.
3. Answer the questions below.

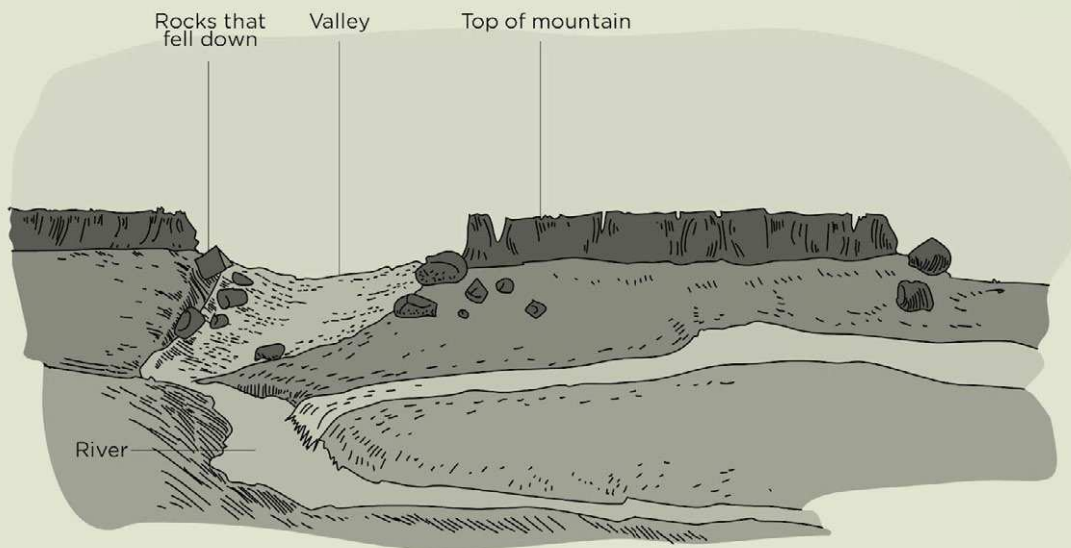

This is how the mountains look now. Draw on this picture to show what the mountains looked like millions of years ago.

QUESTIONS:

1. The rock and sand are being removed from the mountains. How does this happen?

2. Where does the rock and sand go?

3. Draw on the diagram to show how the mountain might have looked many years ago, **before** the rock and sand were eroded.

DID YOU KNOW?

Chalk is a soft, white form of limestone.



NEW WORDS

- cement
- limestone
- sandstone
- shale



Different kinds of sedimentary rock

There are many kinds of sedimentary rock. Here are three kinds:

1. **Sandstone** is made from grains of sand that are cemented together.
2. **Shale** is made from grains of clay that are cemented together. Shale is quite soft and you can use it to write with, like a piece of chalk.
3. **Limestone** is made of layers of shells of sea-animals that died and sank to the bottom of the sea. Other kinds of limestone are made from sea-water evaporating.

3.2 Uses of sedimentary rock

You just saw that there are different types of sedimentary rocks. These rock types are used in different ways.

Limestone

Limestone is a very common sedimentary rock and it has many uses, mostly as building materials.

Limestone is cut into blocks and used in buildings. Look at these pictures below of different buildings made from limestone.



Can you see the blocks of limestone in this building?



This old building is made from limestone blocks and looks like it can withstand anything.

Limestone is crushed and used to make cement. Limestone is often used in sculptures as it can be carved easily.



A sculpture made from limestone.

Glass is made from molten sand, and limestone is mixed with the sand to make the glass stronger. Farmers use limestone to improve their soil, if the soil is too acidic.

Limestone is even used in some medicines and cosmetics and as a white pigment in toothpaste, paints and plastics!

Sandstone

Sandstone has been a popular building material since ancient times, especially in houses and cathedrals around the world. This is because it is quite soft and easy to carve. Houses in Lesotho and the Free State were built from sandstone blocks.



A cathedral in England made from sandstone.

Sandstone comes in many different colours and so it is often used decoratively, such as in decorative stones, in fireplaces, in decorative columns and pillars in buildings and cathedrals and to make statues and fountains. Since sandstone is easy to carve, but does not weather, it is often used as paving stones and to make walkways.



Decorative columns made from sandstone in India.



Decorative carvings and columns made from sandstone on the front of a building.



Paving blocks made from sandstone.

Shale

Shales is also used in buildings, especially as a raw material to make bricks. Shale also splits very easily into thin sheets and is therefore used as as tiles for floors and roofs. Shale is used for floors in some houses in South Africa.



Shale splits easily into thin tiles which can be used in flooring and roofs.

Cement is also made from shale. The shale is crushed to a powder and heated in a kiln (a kind of stove). Black shale rock is also a very important source of oil and natural gas all over the world.



KEY CONCEPTS

- Sedimentary rocks form when small grains of rock, mud and sand form layers and become compacted over a very long time.
- Rock breaks into small grains through the process called weathering.
- Sedimentary rock can be identified as it has visible layers.
- Examples of sedimentary rock are shale, sandstone and limestone.
- Sedimentary rocks have different uses.





REVISION:

Complete the following sentences using words from the Word box. Write the sentences out completely.

Word box: use some of these words to complete the sentences.

- grains
- wind
- water
- sediment
- sandstone
- limestone
- shale
- weathering

1. Weathering breaks grains of rock off of big rocks. _____ and _____ move these grains on top of each other in layers. A layer of rock grains is called a _____.

2. Over many years, the _____ become stuck together and we get sedimentary rock. Three types of sedimentary rock are _____, _____ and _____.

3. Explain how you would identify sedimentary rock in the natural world around you.

4. Explain the difference between erosion and deposition.
Provide a drawing to accompany your answer.



5. Use the space below to draw a series of drawings to show how a rock is broken down into smaller grains over time. Label your drawing to explain the processes that are taking place to break down the rock.

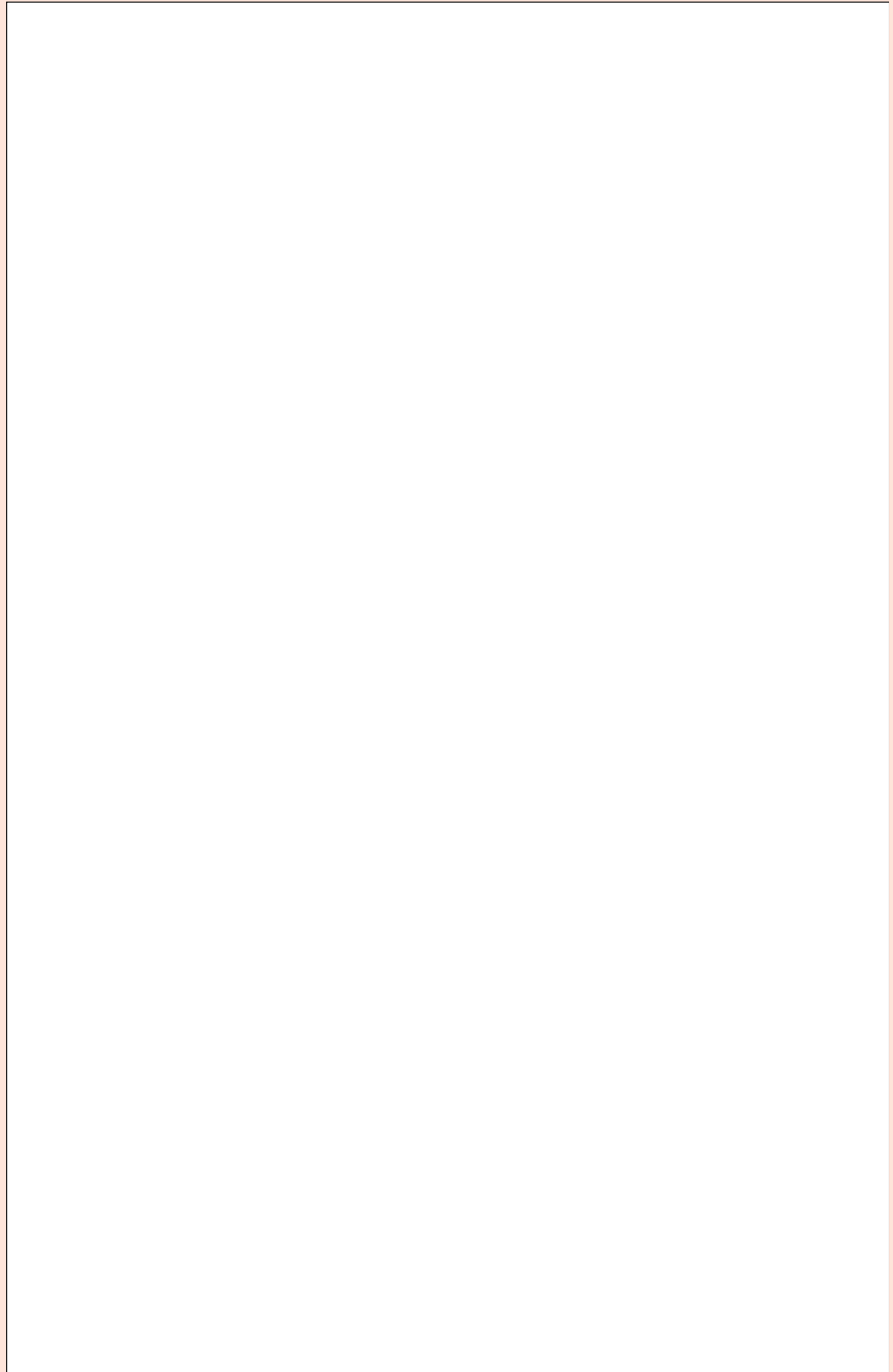



*Now comes the section I
am most excited about -
learning about fossils
and how they formed!
Let's get started!*



KEY QUESTIONS

- What are fossils?
- Why were the animals long ago different to animals we can see nowadays?
- How do fossils form in rocks?
- Why are fossils so important?
- What is the Cradle of Humankind in South Africa? Why is it a World Heritage site?

NEW WORDS

- fossil
- ancient
- evidence
- record
- preserve

4.1 Fossils in rock



These old photographs are of fossil hunters! These people are splitting open pieces of shale. They are looking for fossils in the rock. The layers of the shale split apart and he sees the shape of a leaf or an animal in the rock. The shape is called a fossil.

All over the world, people find fossils of leaves and bones in the layers of sedimentary rock. These leaves and bones came from plants and animals that lived millions of years ago. They were not like the plants and animals we see today.

Fossils are rock shapes of dead plants and animals

A fossil is not the real leaf or bone you see; the rock has kept the **shape** of the leaf or the bone. This rock shape is called a **fossil**.

DID YOU KNOW?

A paleontologist is a scientist who studies prehistoric life, mostly by looking at fossils.



Below you can see a photo of a fossil of the head of a dinosaur, and the next image shows you what scientists think this dinosaur looked like.



The fossil shape of the head of Massospondylus, a dinosaur that lived in the eastern Free State about 200 million years ago.



Paleontologists think that Massospondylus looked like this.

This fossil of the dinosaur's head is not the actual bones, but it is actually now a rock in the shape of the dinosaurs bones. Over millions of years, the bones turned into rock. So, a fossil is the remains of an ancient plant or animal which has been preserved in a rock. Most of the organisms that paleontologists study are now extinct. This means that they are no longer alive today.

Why are fossils so important?

The Earth's past is fascinating to us! Imagine being around when all the dinosaurs were walking on Earth. As humans, we want to find out about Life's History on Earth.

In recent history, we have books written to record what happened. We can look up in a book and read what someone who lived long ago wrote about that time period. But no human was around millions of years ago to record what happened then!

So we have to use other ways to find out about what life was like on Earth millions of years ago. To do this, scientists use fossils! Fossils are actually our most valuable source of information about the ancient past!

But what can fossils tell us about life long ago? Fossils tell us about

VISIT

Find out how scientists use fossils to recreate dinosaurs.
(video)
goo.gl/uKzeQ



VISIT

Early dinosaur evolution. (video)
goo.gl/tWnJe



the organisms that lived long ago. Imagine the first scientists that discovered a dinosaur's bones! These bones were much bigger than the bones of any other animal on Earth today! This immediately told the scientists that the animals from the past were really big!



The bones of the Tyrannosaurus Rex tell us that it was very, very big!

VISIT

When a T-Rex attacks!

(video)

goo.gl/v4Ne



Fossils can tell us much more than just which organisms lived millions of years ago. By studying fossils of plants and animals, scientists can also work out information on how these organisms grew, what they ate, the environment they lived in and even some aspects of their behaviour and how they interacted!

For example, studying fossilized faeces of an animal can give evidence about what an animal used to eat.

By working out which plants used to grow during a particular time period in Earth's history, scientists can work out what the climate was like during that time. We now know when there were ice ages where the whole Earth was covered in ice for thousands of years, and when it was warmer and there were droughts.



This may just look like a colourful rock, but it is actually fossilized wood. It was created millions of years ago when a forest was buried under mud.



This is a close up photograph of a fossilized tree trunk. It is not wood anymore, but has turned to stone over millions of years. Can you see the rings?



This is a fossilized fern.

A fossilized footprint can tell lots of things about a prehistoric animal, such as how much it weighed, how big it was, and even at what speed it was running!

DID YOU KNOW?

Ferns are actually prehistoric plants! Ferns are some of the oldest surviving organisms on Earth as they were around when dinosaurs walked on our planet.





Can you see the dinosaur tracks?!

Also, the layers of rock which are lower down will be the oldest as they were deposited first. So the fossils in these layers will be from earlier times than fossils in rock layers which are closer to the surface.

VISIT

How are fossils formed?
goo.gl/qyZTC



How did the bodies of animals and plants get into the rock?

Have you perhaps seen the body of a dead bird? Dogs, flies, ants and beetles all take away the parts of the body. The wind blows away the feathers and soon there is nothing left to see.

But sometimes it does not happen like that. Imagine an animal died near a river. There was a flood and the river quickly covered the body with sand. In years after that, more floods brought more sand and put it on top. The heavy sand pressed down on the bottom sediments. Slowly, the bottom sediments became sedimentary rock.

Let's try to make our own model to understand how fossils are formed in sedimentary rock!

ACTIVITY: How to make a model of a body fossil

Fossil-hunters look for fossils in sedimentary rock. They never know whether they will find a fossil or not. They have to split open the rock layers to see any fossil. You are going to make a model of some rock that you will split open.

MATERIALS:

- small container: a plastic dish that you can cut up, or the bottom of a milk carton
- a leaf with ribs that stand out, or
- an animal bone, for example, a chicken bone
- a little Vaseline
- Plaster of Paris

INSTRUCTIONS:

Each group must make a model rock with a fossil.

Day One:

1. First, spread Vaseline over the back of your leaf, or your chicken bone.
2. Next, take your cardboard container to your teacher. Pour the fresh Plaster of Paris mixture into the container. The Plaster of Paris will begin to set hard in about 10 minutes, so you must be ready with your bone or leaf.
3. Now put your leaf or bone onto the top of the wet Plaster of Paris, and press it gently into the plaster. The bone must go in **only half-way** as you see in in the picture below. The leaf must go only far enough to leave the shape of its ribs in the plaster.



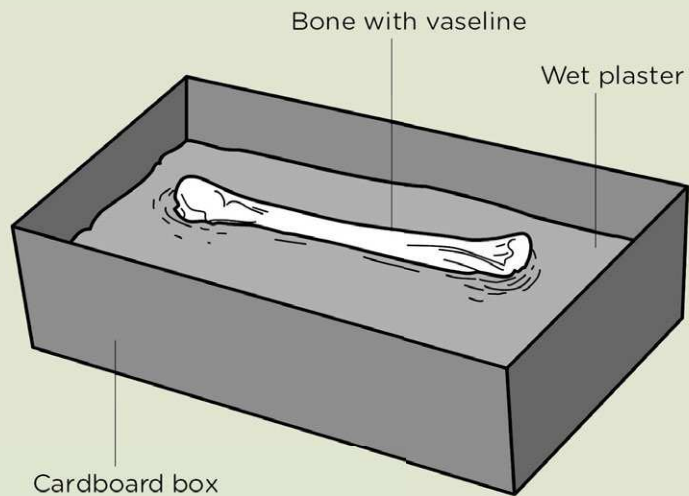

Press the bone only half-way into the plaster.

4. Leave the plaster to set (to get hard). Notice how hot your container becomes while the plaster is setting.

Day Two:

5. First, pull out the leaf or the bone. It will come out easily because the plaster does not stick onto the Vaseline.
6. Now you have an **impression** of the leaf or the bone. An impression is like a footprint in mud.
7. Next, spread a very thin layer of Vaseline into the impression and around the impression, as you see in the picture below.

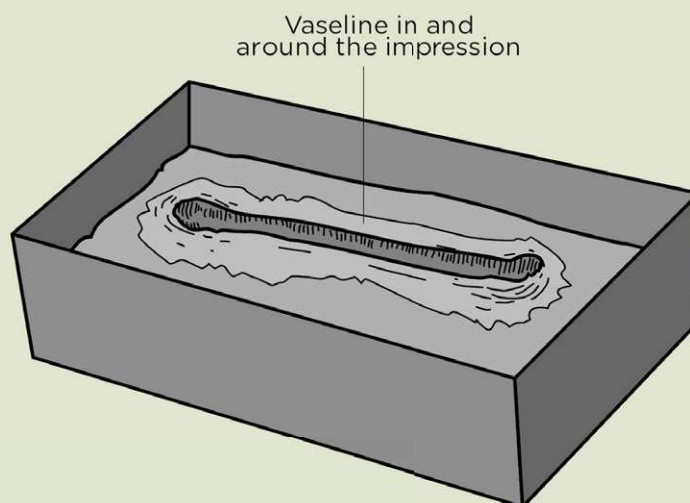

When you pull the leaf or bone out, you leave an impression in the hard plaster. Smear Vaseline into the impression and around it.

8. Then, collect some runny wet plaster of Paris from your teacher and pour it over the Vaseline to cover the old plaster and fill the container almost to the top. Let the new plaster set for a day.

Day Three

9. Tear off the cardboard or plastic container from the plaster "rock" you have made. The fossil is hidden inside. You can paint the plaster to look like a rock.

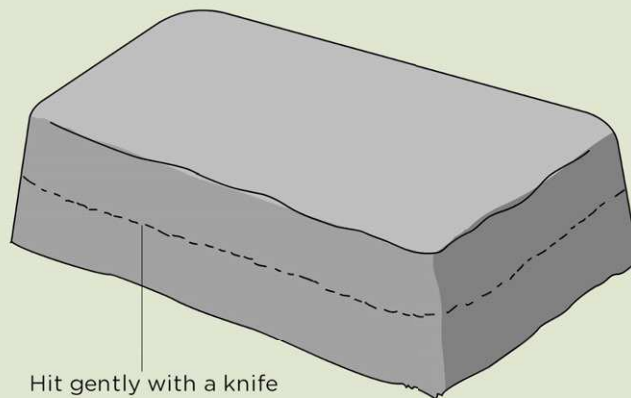

Get a plaster "rock" from another group, and tap gently on the side of their "rock".

10. Now give your "rock" to another group and get a different rock from them. Do not tell the other group what fossil is in your "rock".
11. Use the knife to tap gently on the edge of the "rock". Use a stick to tap on the back of the knife blade, so that you do not hit too hard.

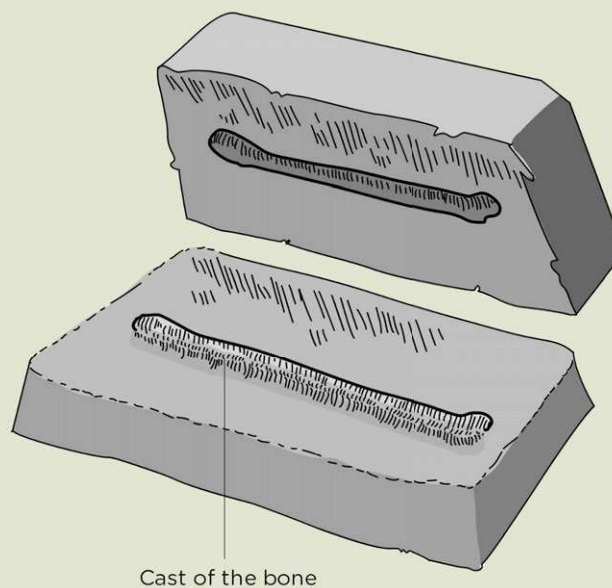

You should find a cast of the bone.

12. Your "rock" should split open if you tap in the right place. When it splits open, you will see a **cast** of a leaf or a bone on the top layer. The cast has the shape of the impression, but the impression goes inward and the cast stands up.

QUESTIONS:

1. Look carefully at the cast and try to draw the leaf or the bone as it really was.

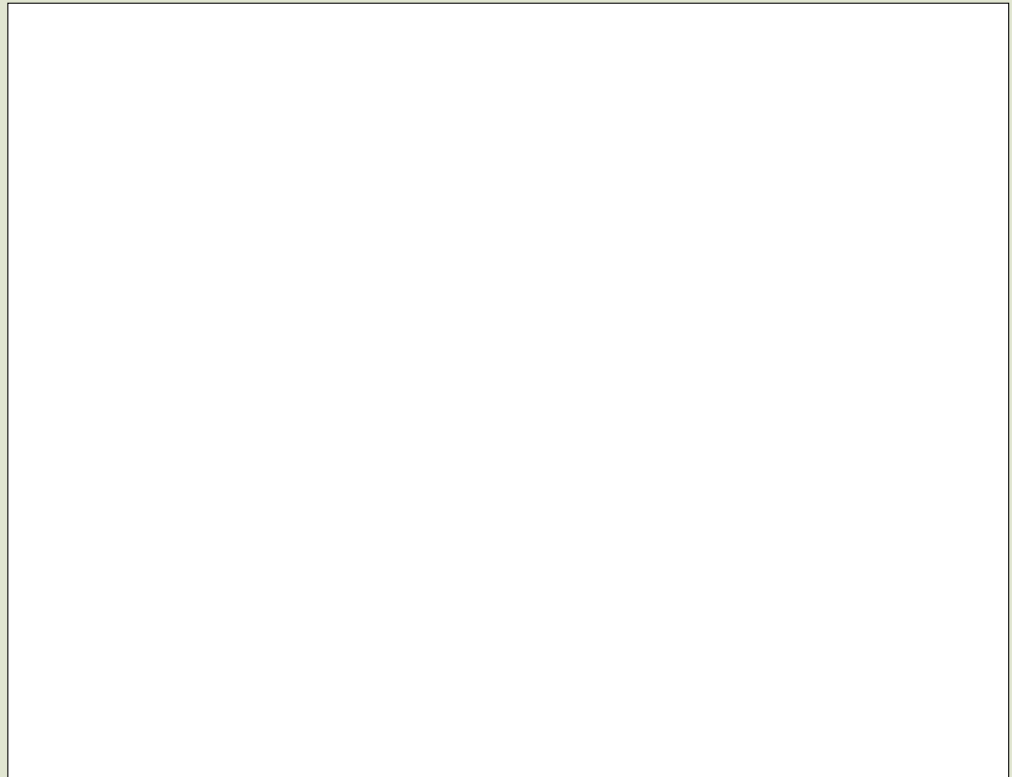

2. Try to work out what kind of plant the leaf came from, or what kind of animal the bone came from.

3. Is the cast (the shape) really a bone, or really a leaf?

4. Do you remember learning about plaster of Paris in the second term in Matter and Materials? What properties of plaster of Paris make it useful in this activity?

Now that you have seen an impression of an object can be made by using Plaster of Paris, let's have a closer look at how a dinosaur fossil were made millions of years ago.

Look at the pictures below and read the explanations for each stage of the fossil formation process.

Long, long ago, a dinosaur dies on the banks of a river, such as this triceratops in the picture.

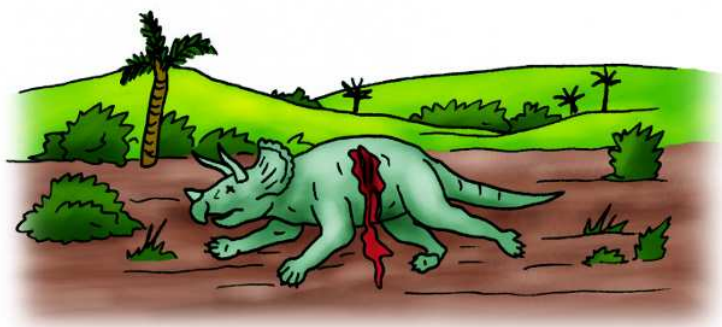

The flesh of the dinosaur decomposes, or other animals eat it. So, only the skeleton remains.

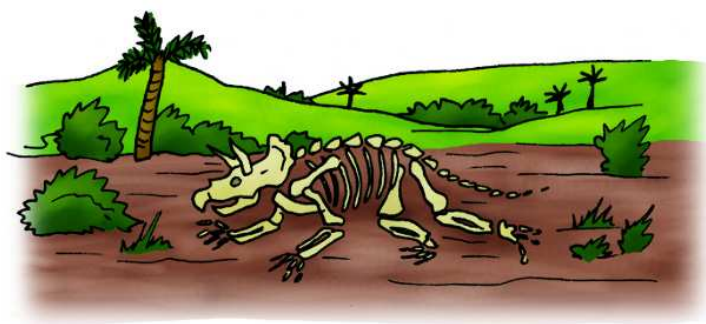

There was a flood and the river rose and covered the skeleton with mud and sand.



Over time, more floods deposit more layers of sand and mud over the skeleton. Over thousands of years, the bottom layers start to become compacted and turn into sedimentary rock. Under the ground, water carried substances from rock into each little space where a bone had been. Rock took the place of bone. We say the bones were fossilised. A fossil bone has the same shape as the original bone, but is much heavier.

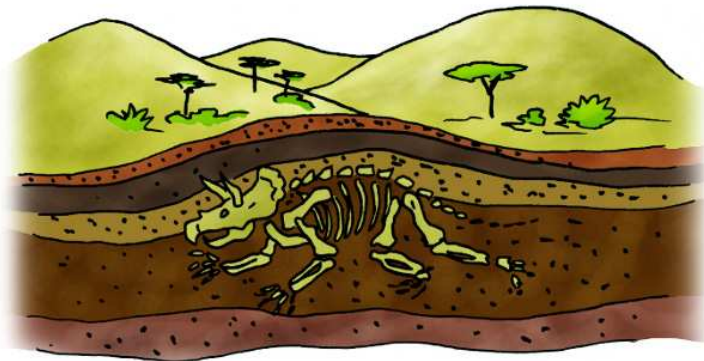

Millions of years later, the conditions of the environment above the skeleton may change. The rock is eroded and weathered over time by wind and water and the fossil is exposed on the surface. A scientist sees the fossil and a great discovery is made!



Other scientists join in and they excavate the fossil by carefully removing the rock and sand around the skeleton. The fossils will be carefully packed and taken to a museum or research centre where the scientists will study them to see what they can learn about prehistoric life. They will try to reassemble the bones into a full skeleton - this may take many months to do!



VISIT

Fossilization video.
goo.gl/b906Z



4.2 Body and trace fossils

We have seen many different fossils so far in this chapter. These fossils can be divided into two groups:

1. Body fossils
2. Trace fossils

A body fossil shows you the shape of the body of the plant or animal. Body fossils include teeth, bones, shells, stems, leaves and seeds.

Sometimes an animal left only a sign that it has been there. For example, if you walk across wet cement, you might leave a footprint which will be preserved in the cement when it hardens. Look at the picture below.



A footprint which has hardened in the cement.



A dinosaur left its footprints in the mud, and the mud turned to rock. This is a trace fossil.

NEW WORDS

- body fossil
- trace fossil



Some ancient animals, like dinosaurs, may have walked across wet mud and left footprints in the mud, like in the picture below. The dinosaur leaves a trace behind. Over millions of years, this footprint can be preserved and become a trace fossil.



QUESTIONS

Use the diagram below as well as your previous knowledge of how sedimentary rock forms to write captions for each stage of the formation of a trace fossil.

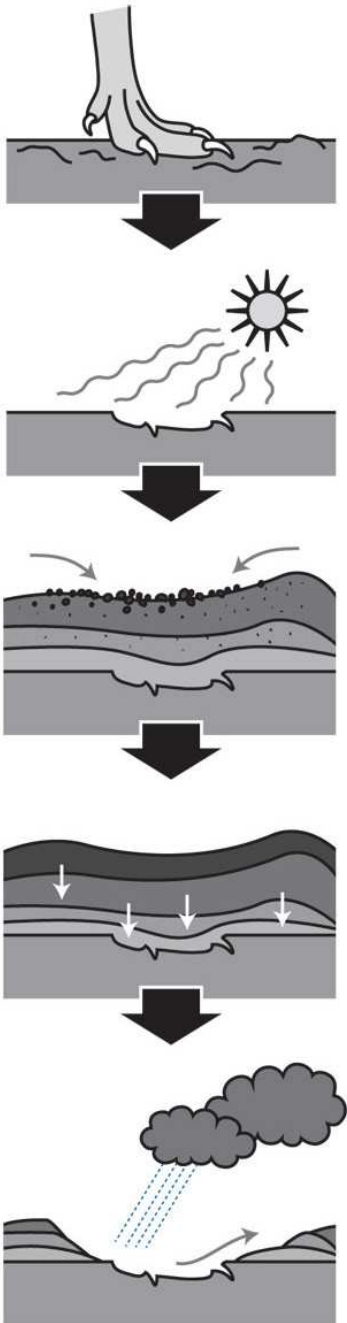

Trace fossils were also made from animals' nests, eggs and droppings.

Some fossils of ancient organisms look similar to plants and animals that are alive today.



Picture of some marine fossils which look very similar to the shells we get today.

4.3 Importance of South African fossils

Did you know that South Africa is world famous when it comes to important fossil finds? South Africa has a very rich fossil record of plants, animals and early humans. Let's take a look at some of these.

QUESTIONS

Do you know of any important fossil findings in your area? If so, write them down below. If not, find out where the nearest fossil finding is to you and write it down.



Earliest life forms

Some of the most ancient fossils that are known to exist were found in rocks in the Barberton area in Mpumalanga.

Do you know where this is in South Africa? Look it up on a map! These fossils are more than 3000 million years old! That is very, very old. They look like blue-green bacteria.



QUESTIONS

What are bacteria? Find out and write a short explanation below.

Earliest plants

Do you know where Grahamstown is in the Eastern Cape? Grahamstown is famous in the archaeological world for having some of the oldest and best preserved fossils of early plants from millions of years ago.

Look at the shape of Africa and South America on the classroom globe. The shapes could fit together like in this picture below. This diagram shows how scientists think the continents of Earth used to look millions and millions of years ago. This was called Pangaea.

A South African scientist thought that perhaps Africa and South America had been joined together long ago. But nobody knew if this was true.

Then scientists found fossils of a plant called Glossopteris in rocks in South Africa and they found fossils of the same plant in South America. This made more people think that perhaps Africa and South America were once joined, very long ago. The image below shows how scientists think the plant Glossopteris used to grow in the world, in the dark green.

NEW WORDS

- Pangaea
- Glossopteris
- therapsids
- ancestor
- coelacanth

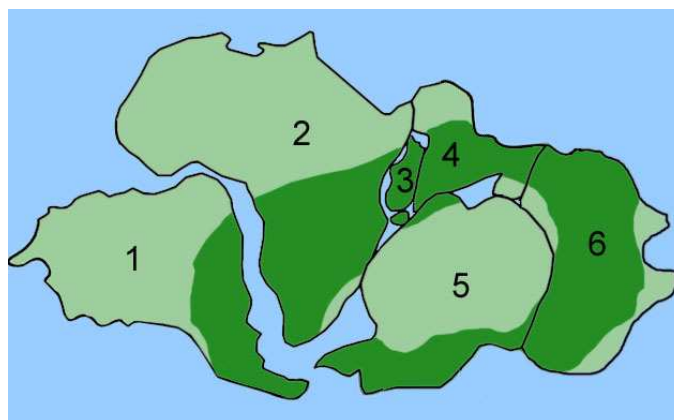

Pangaea, showing the distribution of Glossopteris in dark green.

QUESTIONS

Which number represents South America and which number represents Africa today?



These are fossils of Glossopteris leaves.

QUESTIONS

Do you think this fossil of Glossopteris leaves is a trace or body fossil? Explain your answer.



Dinosaurs

Fossils of dinosaurs have been found all over the world. But, one of the best places in the whole world to find dinosaur fossils is the sedimentary rock in the Drakensberg Mountains and the Maluti Mountains in southern Africa.



QUESTIONS

Where are the Drakensberg Mountains located in South Africa? Write down the names of the provinces.

Mammal-like reptiles



A fossil of a therapsid found in the Karoo. A therapsid is a small dinosaur with some features of mammals.

Reptiles came before mammals. But the fossil record shows us some animals which were similar to mammals as we know them today, but they were actually reptiles. They were in between! They are called Therapsids. Fossils of these animals have been found in the Karoo in South Africa.

Fossils of some of the first mammals on Earth were also found in the Drakensberg rocks in the Eastern Cape and in Lesotho.



QUESTIONS

Where is the Karoo? A town in the Karoo is Graaff Reinet. Find this town on the classroom globe. Find it on a map. Name some other towns found in the Karoo.

A strange fish that lives in the sea near South Africa

Look at the picture below. You will see a fish that was caught in the sea near East London. The fish is called a Coelacanth.



A preserved coelacanth in a museum.

Scientists from other countries rushed to South Africa to see this Coelacanth fish. They could not believe that any Coelacanths still lived in the sea. The scientists knew about Coelacanths because they had studied their fossils in England and Germany, but the fossils were 80 million years old. The scientists thought that Coelacanths had all died millions of years ago! We now call coelacanths "living fossils"!

QUESTIONS

How is this fish different from other fish? Look at its tail and its front fins.

The Cradle of Humankind

The Cradle of Humankind is a World Heritage Site. It is called the "Cradle of Humankind" as many people and scientists now believe that this was where humans first evolved. The birthplace of humans is right in our country!

VISIT

Finding the
coelacanth (video).
goo.gl/pu6la



VISIT

Coelacanth
discoveries (video).
goo.gl/clYvX



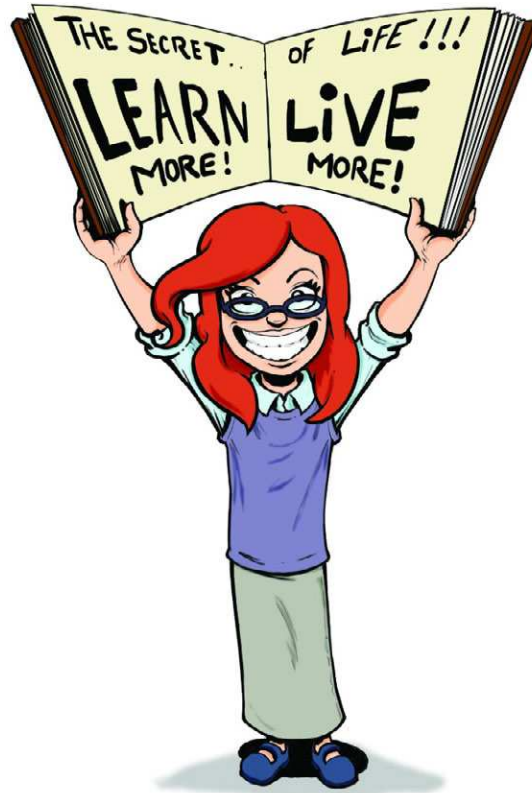

I just love learning more and more about what makes our country so special and wonderful and we can be proudly South African!



QUESTIONS

What does it mean if a place is a World Heritage Site? Find out and write your answer below.

The Cradle of Humankind is found in Maropeng just outside of Johannesburg in Gauteng. The name Maropeng, a Setswana word, means "return to place of origin"



The museum at Maropeng, Cradle of Humankind.

In the Cradle Of HumanKind about 1000 fossils of pre-humans have been discovered, dating back millions of years!

Altogether there are 15 major fossil sites in the Cradle of Humankind. The Sterkfontein Caves is the most famous. Swartkrans and Bolt Farm are also sites at Cradle of Humankind where fossils have been found.



The entrance to Sterkfontein Caves is down a long, winding staircase.

The fossils of "Mrs Pleis" and "Little foot" were both discovered at Maropeng, as well as thousands of hominid fossils, which are human ancestors, as well as plants and animals.

VISIT

The Cradle of
Humankind website.
goo.gl/ZDkU7





The cranium of an Australopithecus Africanus found in Sterkfontein caves at Maropeng

Tourists come from all over the world, including South Africa, to view the caves and fossils at the Cradle of Humankind and get immense knowledge on the history of humankind. If you live in or near Johannesburg, maybe you have been lucky enough to visit Maropeng and the Cradle of Humankind?!



ACTIVITY: Thinking about the Cradle of Humankind

Use the information above on the Cradle of Humankind to answer the questions below.

1. Why is the Cradle of Humankind famous?

2. Explain why you think it is called "The Cradle of Humankind".

3. Give the names of two of the most famous hominid fossils that have been found at the Cradle of Humankind.

4. Explain why you think the fossils at Maropeng are protected by the country's law.

5. Which of the following is not one of the fossil sites in the Cradle of Humankind? Circle it.

- Sterkfontein Caves
- Cango Caves
- Swartkrans
- Bolts Farm

6. What does Maropeng mean?

As we have seen, there are many important fossil findings all over South Africa! Let's put all these places on a map in the next activity.

ACTIVITY: Plotting the important fossil sites in South Africa

INSTRUCTIONS:

1. Identify all the places that have been mentioned in this Chapter which are important archaeological sites in South Africa.
2. Find these places on the map of South Africa and mark them in with an X and the name.
3. Next to the place names, write down the important fossils which were found there.



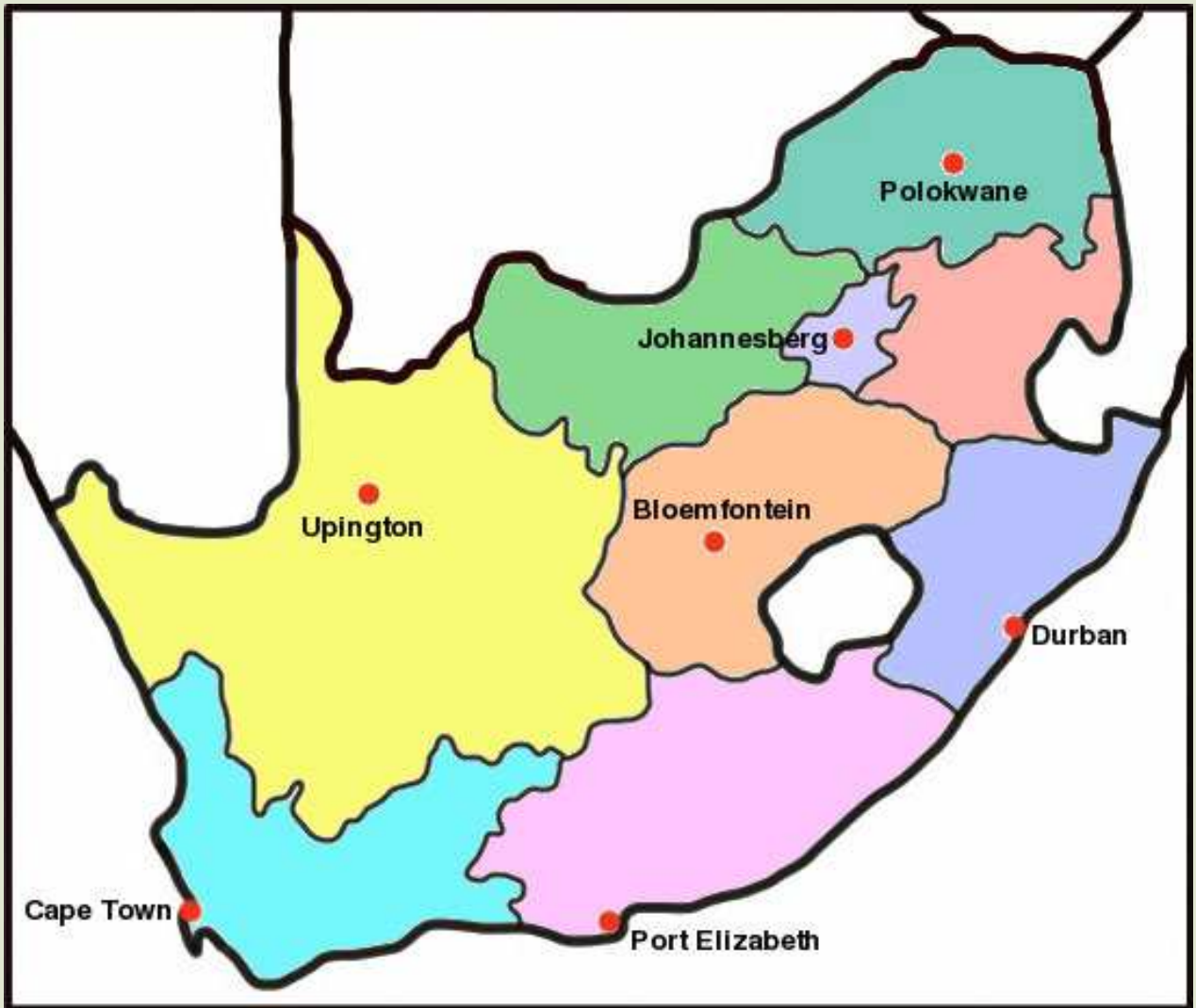

KEY CONCEPTS

- Animals and plants sometimes died in mud, and the mud keeps their shape or preserves their remains.
- These remains of ancient plants and animals are called fossils.
- There are two main types of fossils - body and trace fossils.
- Fossils provide us with a record of the history of life on Earth.
- South Africa has a very important collection of fossils.

REVISION:

1. Are animal fossils made of bone? Explain what a fossil is.

2. Which type of rocks are fossils normally found in?

3. Why do you think we only find fossils in this type of rock?

4. Fossil wood does not burn. What is the reason?

5. Some rock comes out of a volcano. It is red hot and then it cools and becomes hard. Can you find fossils in rock like this? Why?

6. Name two fossils that show us the kinds of living things that lived long ago in South Africa.

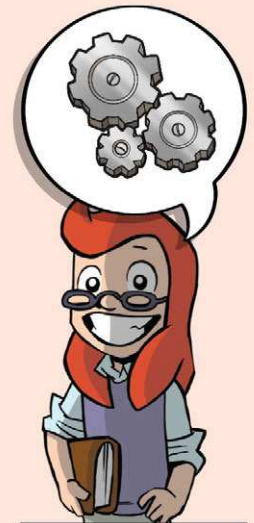

7. Explain how you think fossils can help us understand what life was like long ago on Earth.



*That's all! We are finished
with Grade 5!!*

Chapter 1 Stored energy in fuels

1. <http://www.flickr.com/photos/26660287@N02/2730793586/>
2. <http://www.flickr.com/photos/josephferris76/5458909986/>
3. <http://www.flickr.com/photos/caitlinator/90510565/>
4. <http://www.flickr.com/photos/l2f1/6970703527/>
5. <http://www.flickr.com/photos/38449766@N03/3602997918/>
6. <http://www.flickr.com/photos/89241789@N00/172762899/>

Chapter 3 Energy and movement

1. <http://www.flickr.com/photos/mwichary/2140389736/>
2. <http://www.flickr.com/photos/aidanmorgan/4091893094/>
3. <http://www.flickr.com/photos/lobo235/59008266/>

Chapter 4 Systems for moving things

1. <http://www.flickr.com/photos/jaybergesen/3335698859/>
2. http://commons.wikimedia.org/wiki/File:Rollingstock_axle.jpg
3. <http://www.flickr.com/photos/oceanyamaha/180500640/>
4. <http://www.flickr.com/photos/ulybug/528293273/>
5. <http://www.flickr.com/photos/yourdon/3571194483/>

Chapter 2 Surface of the Earth

1. <http://www.flickr.com/photos/mjtmail/3823526817/>
2. <http://www.flickr.com/photos/wyrdo/3911919025/>
3. http://www.flickr.com/photos/chris_e/693822380/
4. <http://www.flickr.com/photos/credashill/6773976264/>
5. <http://www.flickr.com/photos/soilscience/5097649628/>
6. <http://www.flickr.com/photos/sroown/797820971/>
7. <http://www.flickr.com/photos/misskei/137166251/>

Chapter 3 Sedimentary rocks

1. <http://www.flickr.com/photos/42244964@N03/4467294790/>
2. <http://www.flickr.com/photos/jgphotos95/6914965980/>
3. <http://www.flickr.com/photos/crabchick/2567814666/>
4. http://www.flickr.com/photos/st_a_sh/478485443/
5. http://www.flickr.com/photos/old_dog_photo/4028600091/
6. <http://www.flickr.com/photos/crabchick/2567814666/>
7. http://www.flickr.com/photos/grand_canyon_nps/6050775941/
8. <http://www.flickr.com/photos/editor/4914295602/>
9. <http://www.flickr.com/photos/nathanmac87/5824306467/>

10. <http://www.flickr.com/photos/takomabibelot/1044959169/>
11. <http://www.flickr.com/photos/ell-r-brown/5870376807/>
12. <http://www.flickr.com/photos/archer10/2214268419/>
13. <http://www.flickr.com/photos/shinythings/440512646/>
14. http://www.flickr.com/photos/garden_and_landscape_design_products/3425879229/
15. <http://www.flickr.com/photos/amerune/52827189/>

Chapter 4 Fossils

1. http://commons.wikimedia.org/wiki/File:August_1,_2012_-_Massospondylus_carinatus_Fossil_Skull_on_Display_at_the_Royal_Ontario_Museum_%28BP-I-4934%29.jpg
2. http://commons.wikimedia.org/wiki/File:Massospondylus_BW.jpg
3. <http://www.flickr.com/photos/kateure1309/6455258351/>
4. <http://www.flickr.com/photos/ivanwalsh/4651461744/>
5. <http://www.flickr.com/photos/mjtmail/3395743283/>
6. http://www.flickr.com/photos/col_and_tasha/6952273414/
7. <http://www.flickr.com/photos/93057807@N00/376794489/>
8. <http://www.flickr.com/photos/mcdltx/463546150/>
9. <http://www.flickr.com/photos/jelles/465981452/>
10. <http://www.flickr.com/photos/flowcomm/4511632159/>
11. <http://www.flickr.com/photos/sybarite48/4067495697/>
12. <http://www.flickr.com/photos/flowcomm/4175169200/>